





Visit baofengradios.com for Download and Help

BAOFENG

Thank You Shopping at BAOFENG!
FIND TUTORIALS, SUPPORT AND MORE

 <https://baofengradios.com/>
 <https://facebook.com/baofengIND>
 <https://youtube.com/@baofeng-india>



Visit baofengradios.com for Download and Help

BAOFENG

Two Way Radio

BF-9700/PMR446

User Manual



Visit baofengradios.com for Download and Help



Visit baofengradios.com for Download and Help

About BAOFENG INDIA

“You, our friend and customer, are at the forefront of what we do.”

Nothing is more important than your time, and your money. When buying radios online, you face a dilemma: Save time and purchase from a reputable website at a high price, or try to save money by purchasing from an un reputable dealer at the cost of your time spent dealing with quality and service issues. At baofengradios.com. you don't have to choose between low prices and a safe shopping experience. Whether you're a first time buyer or a seasoned HAM, we hope you'll find our products, prices, content and resources to be just what you need.

In the past several years, Baofeng India has been better serving the needs of two-way radio buyers creating a safe shopping experience. We do this by providing the highest quality products, at an affordable price, and backing that up with superior quality service. It sounds simple to us.

That is our promise: to improve your buying experience. Through strong partnerships which allow us to bring you the latest technology from our own brand BAOFENG and on behalf of our caring and responsive Customer Support team, we strive to fulfill that promise and better meet your needs every day.

Along with this promise, we hope to give you more value. Be that by offering you the latest and greatest in DMR and analog radios, accessories and related products, by providing superior technical support, or by working with thought leaders in the Amateur Radio Industry to develop enriching content to entertain and assist you in your buying process including our Blog, FAQ, and Newsletter. Your concerns are our concerns.

We do all of this to help you find the highest quality of radios, for low prices, with as little headache to the consumer as possible. If we are failing you in this promise in any way, let us know via email, Support@baofengradios.com



Visit baofengradios.com for Download and Help

Table of Contents

Chapter 1. Getting started	01
Safety Information	01
What' s in the box	03
Chapter 2. Getting started	04
Battery Maintenance	05
Charging	06
Chapter 3. Basic operation	07
Quick Start Guide	07
Scan Function	08
Battery Save Function	10
Busy Channel Lockout	11
Wide/Narrow Bandwidth Setting	12



Visit baofengradios.com for Download and Help

VOX	12
Voice Prompt	14
Low Battery Indication	15
Squelch	16
Time-Out-Timer(TOT)	17
CTCSS/DCS	18
Side Key Custom Setting (Monitor/Alarm)	19
Chapter 4. Computer Programming	21
Chapter 5. Trouble Shooting Guide	23
Appendix A. Product Safety Guide	25
Appendix B. Specifications	31



Visit baofengradios.com for Download and Help



Visit baofengradios.com for Download and Help

Chapter 1.-Getting Started

Safety Information

Please read the following brief instructions, non-compliance with these rules may improper use may cause danger and violate the law.

1. Refer to Indian Government WPC regulations before using this radio, improper use may violate the law.
2. Turn off the radio before getting close to combustible or hazardous area.
3. Do not charge the battery in the combustible or hazardous area.
4. Do not use the damaged antenna, which will easily get burnt while touching.
5. Do not try to disassemble the radio, the maintenance work should be only done by technical expert.
6. To avoid electromagnetic interference or electromagnetic compatibility, please turn off the radio in places where prohibit from using wireless equipment, such as hospital and other healthcare facilities.
7. In the car with an airbag, do not put the radio within the scope of the airbag long deployment.



Visit baofengradios.com for Download and Help

9. Once the radio is smelly or smoky, please shut off its power immediately.
10. Do not transmit for a long time due to possible heat build-up.

FIND TUTORIALS, SUPPORT AND MORE

baofengradios.com

Support@baofengradios.com

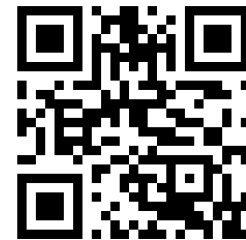

Visit baofengradios.com for Download and Help

What's in the box

Thanks for choosing Baofeng two way radio. We recommend you to check the items listed in the following table before discarding the package box.

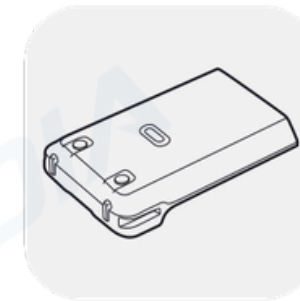

Li-ion battery

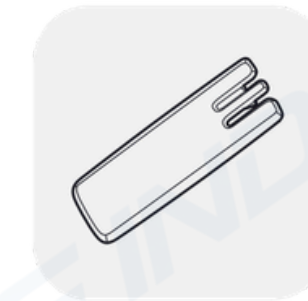

Belt Clip

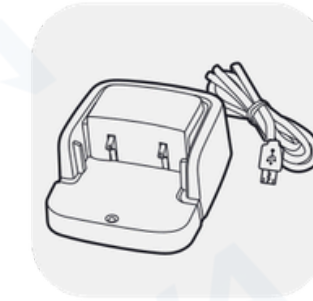

USB Charger



Earpiece



Wrist Strap

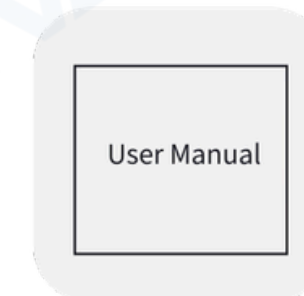

User Manual

Note: The radio is compatible with other accessories which are available on:

<https://baofengradios.com>

- Speaker microphone
- Programming cable
- Earphone

8.-RADIO OVERVIEW:

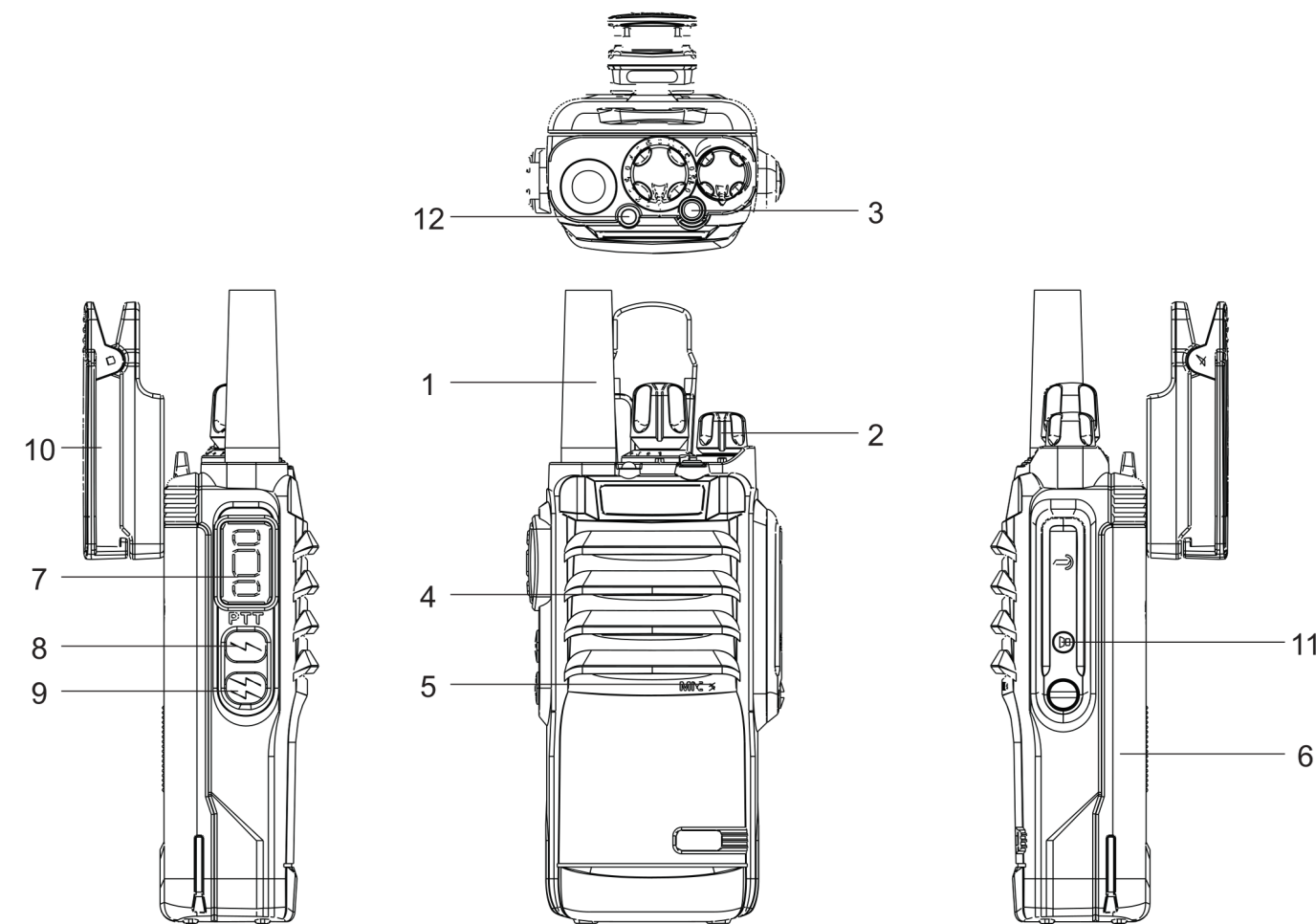

1. Antenna	6. Battery latch	11. Accessory jack
2. Knob (ON/OFF, volume)	7. PTT	12. LED indicator
3. Flashlight	8. SK-side key1/F	
4. Speaker	9. SK-side key2/M	
5. Microphone	10. Strap buckle	

8.2. - COMMAND/KEY DEFINITION:

Power On:

Rotate PWR/VOL Switch clockwise, you will hear a sound *Beep*, report the present channel, the transceiver is ready for working; meanwhile rotate PWR/VOL Switch to adjust the volume

[SOS]Emergency Alarm:

Long press to open the alarm function, at this moment, the green light, red light, and hand lamp flashes shin at the same time. Press this button again to release the alarm.

[PTT]:

-Press and hold [PTT] button, then talk to the microphone. Release [PTT] to receive.

SK-SIDE KEY1/ [F]:

-Press the [F] button, to activate the FM Radio on; Press it again to deactivate the FM Radio.

SK-SIDE KEY2/ [MONI]:

-Press the [MONI] button, to turn on the flashlight; Press it again to turn off. Press and hold on the [MONI] button, to monitor the signal.



Visit baofengradios.com for Download and Help

Charging

How to use the USB desktop charger:

1. Plug the USB connector into a suitable USB power source. LED will become GREEN indicating ready to commence the charging cycle.
2. Place either the Radio (OFF) or just the battery into charger. Charger LED will show RED indicating the charging cycle has commenced.
3. When the LED turns GREEN, charging has completed and the radio or battery should be removed from the desktop charger.

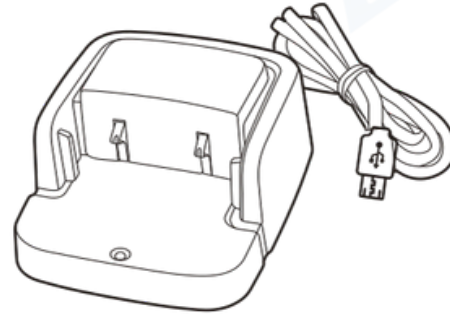

Note

1. Before inserting the battery, it is abnormal if the charging indicator blinks
2. Wait until the indicator is stable before placing battery in charger.
3. When the battery is properly inserted, the indicator turns red and starts the charging process. If the indicator blinks, then the battery is damaged or the temperature is too high or too low

Installing external headset

Gently displace (do not remove) the speaker jack cover, insert the headset into the speaker jack



Visit baofengradios.com for Download and Help

Chapter 3.-Basic operation

Quick Start Guide

1. Carefully open the box and remove radio body, battery and antenna.
2. Install battery in radio body until it clicks (be gentle!) (See specific directions in previous section)
3. Install antenna into radio. (The antenna will smoothly screw into radio.) Do not force or cross threading may occur. Make sure, after about 10 turns, the antenna is fully seated and tight.
4. Turn on power knob by twisting gently counter clockwise. The radio will respond with, "Open the radio, 1," or whatever channel is selected by the taller selector.
5. Select your desired channel, radio will respond with "One, Two, etc."
6. Press the PTT and talk!



Visit baofengradios.com for Download and Help

NOTE

The battery included with the radio generally has enough power in it to test your radio. You should fully charge the battery for optimal performance.

The BF-9700/PMR446 is a cost effective UHF-FM analog radio. It can communicate with any other brand of radio that is UHF-FM analog, but without spending an exorbitant amount of cash! You just need to make sure they are in the same channels/frequencies, and this can be simply checked by using the software. If they are not in the same frequency, just program via computer. (See chapter 4)

1. Scan Function

When the radio is allowed to be scanned, which can be set by the software, you can press the Monitor key to turn on or turn off the scan. When the scan begins the indicators lights green, the radio will scan automatically from channel 1 to 16 which is defined as scan added. When there is signal in the scanning channel, it will stop in that channel.

NOTE

Please note that scan is only available when there are two or more than two memory channels and two or more scan added channels.



Visit baofengradios.com for Download and Help

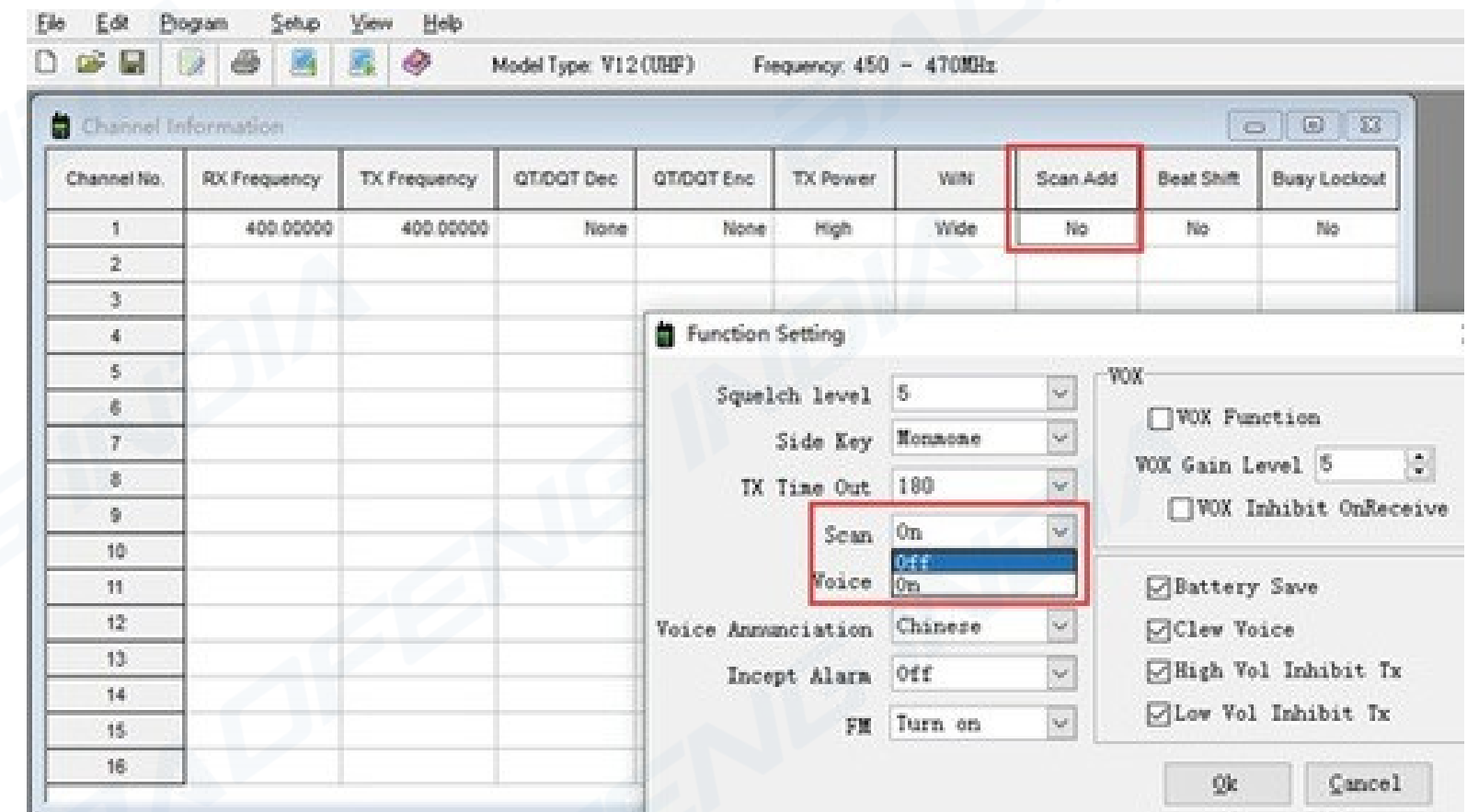



Visit baofengradios.com for Download and Help

2. Battery Save Function

This function can be set by the software.

By turning on this function the standby time can be much longer.

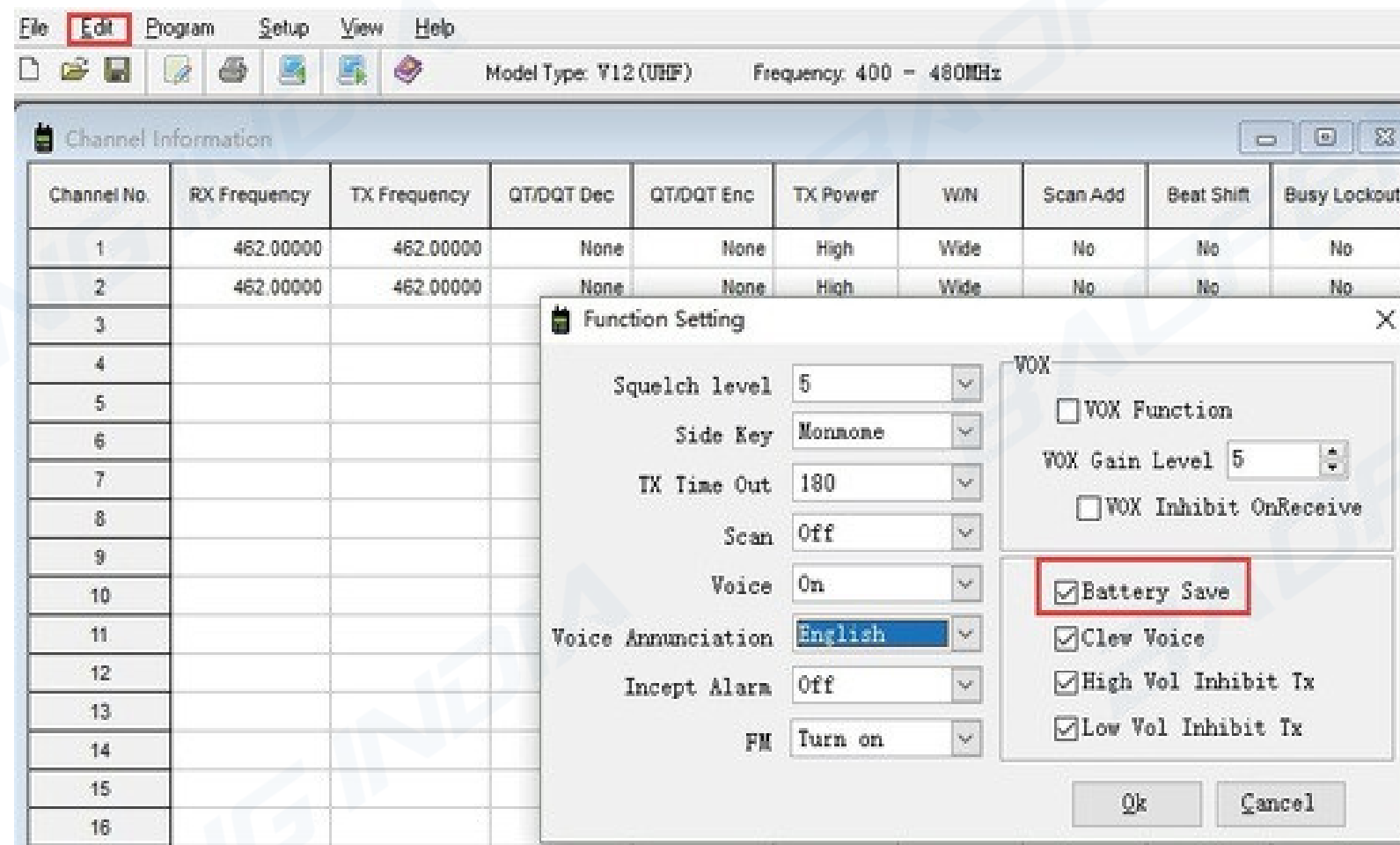

Visit baofengradios.com for Download and Help

3. Busy Channel Lockout

You can turn on/off this function via software.

- A: If the current channel does not have CTCSS/DCS, when there is a signal, TX prohibited when you press PTT.
- B: If the current channel does not have CTCSS/DCS, when there is signal which does not have CTCSS/DCS, TX prohibited when you press PTT.
- C: If the current channels does not have CTCSS/DCS, when there is signal which have CTCSS/DCS, the radio will transmit when you press PTT.

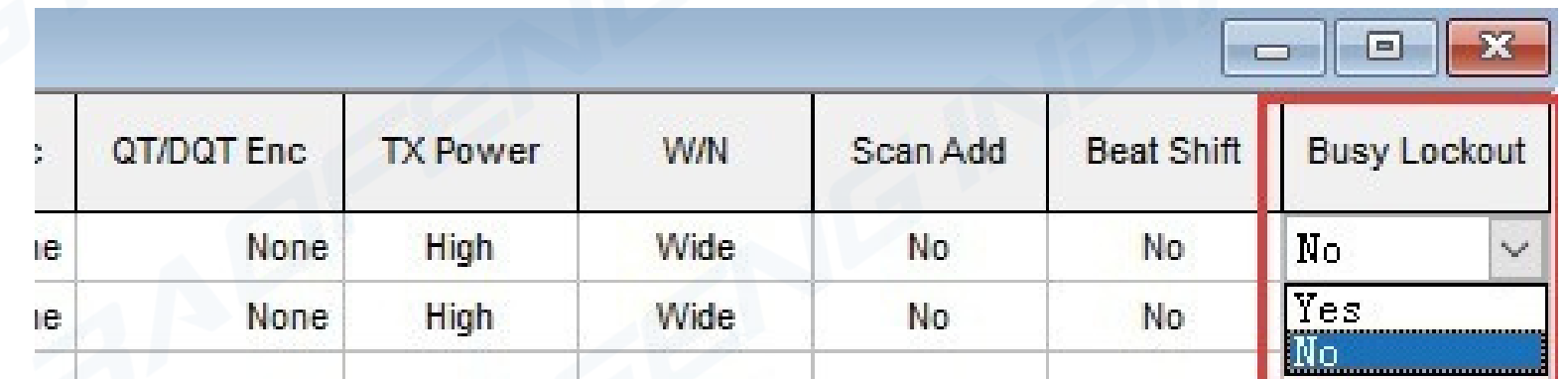



Visit baofengradios.com for Download and Help

4. Wide/Narrow Bandwidth Setting

The default setting is wide band.

Channel No.	RX Frequency	TX Frequency	QT/DQT Dec	QT/DQT Enc	TX Power	W/N	Scan Add	Beat Shift	Busy Lockout
1	462.00000	462.00000	None	None	High	Wide	No	No	No
2	462.00000	462.00000	None	None	High	Wide	No	No	No
3						Narrow			

5. VOX

Speak to the microphone in normal voice to transmit, no need to press PTT switch, turn VOX on/off through the software.

A. When VOX is on in your working channel:

Speak to the microphone directly, it will transmit automatically.

The radio stops transmitting when there is no voice, and waits for receiving.



Visit baofengradios.com for Download and Help

B. When a headset with a microphone is used:

When VOX is on, you should VOX again for the radio to identify voice volume.

If the microphone is sensitive enough, the radio will start transmit.

If the microphone is not sensitive enough, the radio cannot collect your voice. Please adjust your voice volume to guarantee smooth communications.

The screenshot shows the 'Function Setting' dialog box in the software. The 'VOX' section is highlighted with a red box, showing the following settings:

- VOX Function
- VOX Gain Level: 5
- VOX Inhibit OnReceive

Other settings in the dialog box include:

- Squelch level: 5
- Side Key: Monnone
- TX Time Out: 180
- Scan: Off
- Voice: On
- Voice Annunciation: Chinese
- Incept Alarm: Off
- FM: Turn on
- Battery Save
- Clew Voice
- High Vol Inhibit Tx
- Low Vol Inhibit Tx



Visit baofengradios.com for Download and Help

6. Voice Prompt

- 1) The voice prompt can be selected to "English/OFF" through the menu voice/Beep Tone of the "Optional Features" in the software. When choosing OFF, voice prompt turns off.
- 2) Channel annunciation: You will get to know the working conditions of current channel which is being operated.
- 3) Low battery alert: The radio will remind you when the battery capacity reaches the minimum operating voltage.

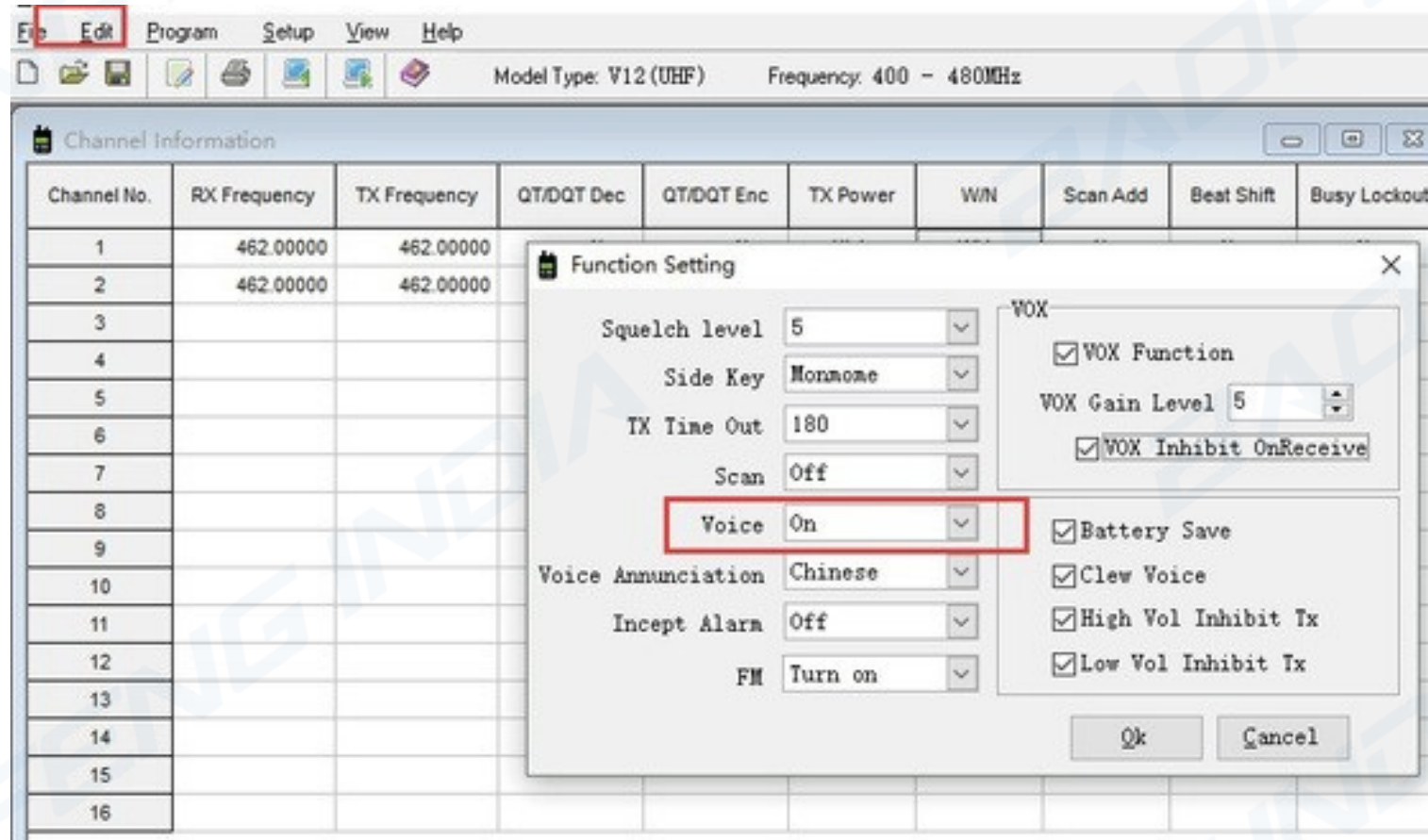

Visit baofengradios.com for Download and Help

7. Low Battery Indication

When the radio is in transmitting or standby, if the battery capacity reaches the pre-determined low level, the indicator light blinks red, and a low battery alert tone will be heard. The indicating tone will be "Please change the battery". When the low battery alert occurs it cannot transmit, please change or charge the battery.

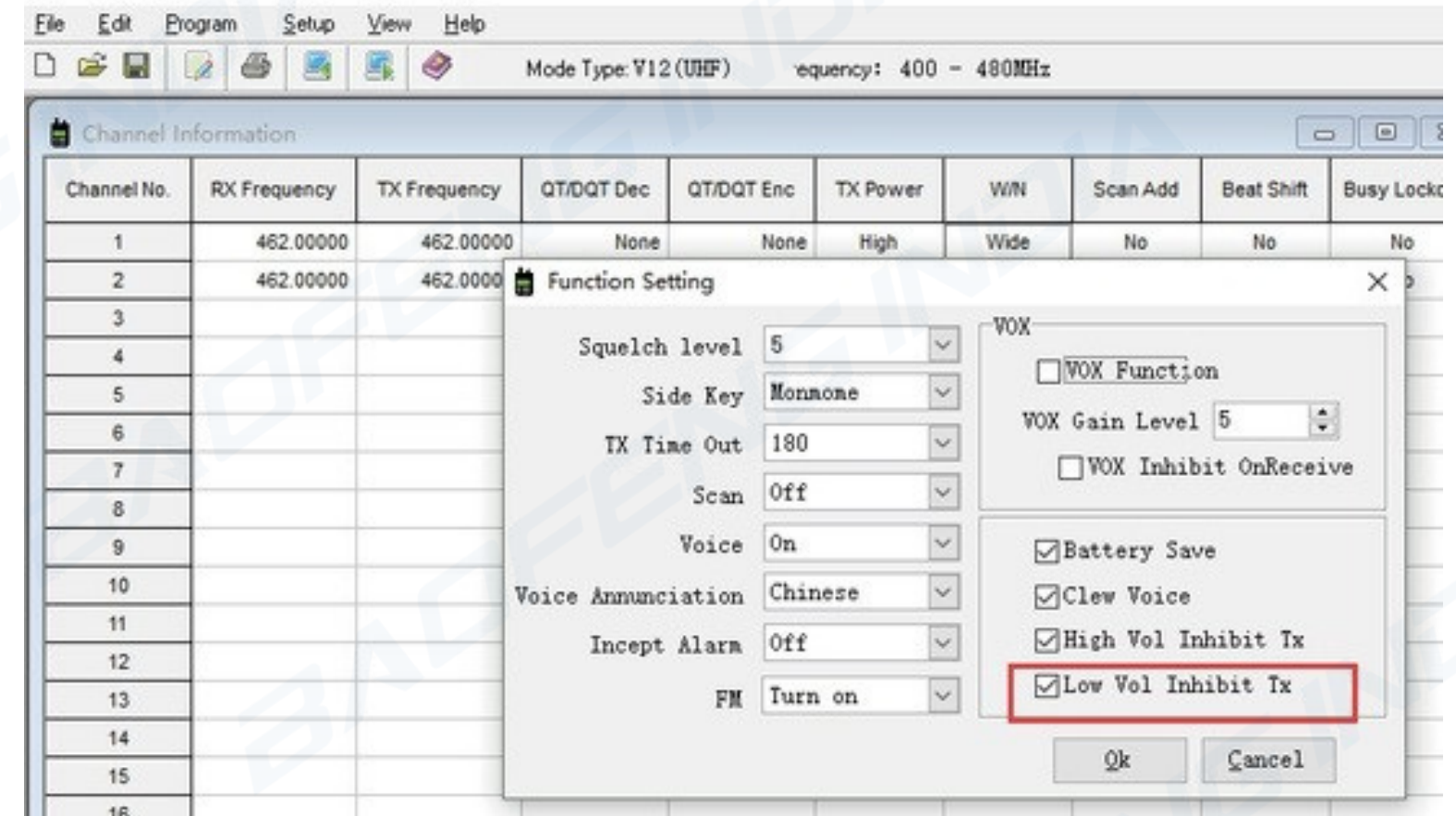



Visit baofengradios.com for Download and Help

10. QT/DQT (CTCSS/DCS)

QT/DQT (CTCSS/ DCS) is the sub-audible signaling, to prevent the radio from receiving unwanted signals on the same frequency. When CTCSS/DCS is set, then within the communication range, you can only receive signals from the same frequency with the same QT/DQT setting. When the QT/DQT is off, you will get all the signals from the same frequency within the communication range.

CTCSS

67.0	69.3	71.9	74.4	77.0	79.7	82.5	85.4	88.5	91.5
94.8	97.4	100.0	103.5	107.2	110.9	114.8	118.8	123.0	127.3
131.8	136.5	141.3	146.2	151.4	156.7	162.2	167.9	173.8	179.9
186.2	192.8	203.5	210.7	218.1	225.7	233.6	241.8	250.3	

DCS

D023N	D025N	D026N	D031N	D032N	D043N	D047N	D051N	D054N	D065N
D071N	D072N	D073N	D074N	D114N	D115N	D116N	D125N	D131N	D132N
D134N	D143N	D152N	D155N	D156N	D162N	D165N	D172N	D174N	D205N
D223N	D226N	D243N	D244N	D245N	D251N	D261N	D263N	D265N	D271N
D306N	D311N	D315N	D331N	D343N	D346N	D351N	D364N	D365N	D371N
D411N	D412N	D413N	D423N	D431N	D432N	D445N	D464N	D465N	D466N
D503N	D506N	D516N	D532N	D546N	D565N	D606N	D612N	D624N	D627N
D631N	D632N	D654N	D662N	D664N	D703N	D712N	D723N	D731N	D732N
D734N	D743N	D754N							



Visit baofengradios.com for Download and Help

D023I	D025I	D026I	D031I	D032I	D043I	D047I	D051I	D054I	D065I
D071I	D072I	D073I	D074I	D114I	D115I	D116I	D125I	D131I	D132I
D134I	D143I	D152I	D155I	D156I	D162I	D165I	D172I	D174I	D205I
D223I	D226I	D243I	D244I	D245I	D251I	D261I	D263I	D265I	D271I
D306I	D311I	D315I	D331I	D343I	D346I	D351I	D364I	D365I	D371I
D411I	D412I	D413I	D423I	D431I	D432I	D445I	D464I	D465I	D466I
D503I	D506I	D516I	D532I	D546I	D565I	D606I	D612I	D624I	D627I
D631I	D632I	D654I	D662I	D664I	D703I	D712I	D723I	D731I	D732I
D734I	D743I	D754I							

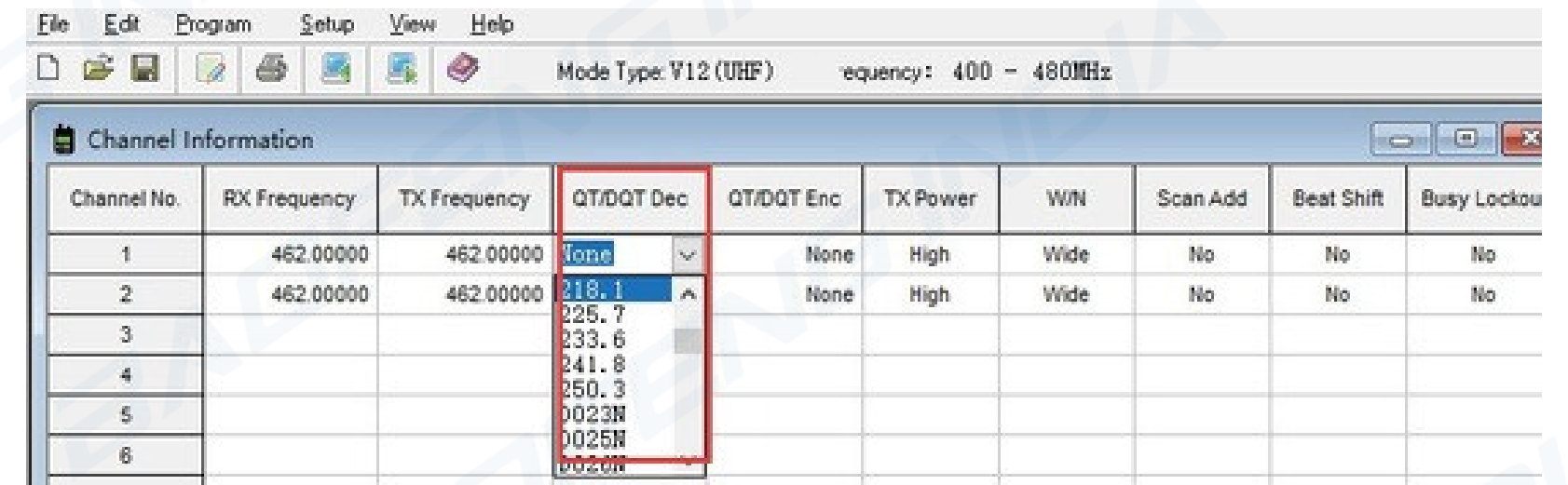

11. Side Key Custom Setting (Monitor/Alarm)

You can custom the second side key as Monitor key or Alarm key by programming in the CPS software.

Click Edit > Function Setting, under “Side Key”, you can activate 3 optional functions: “Off” means side key function is unavailable, “Monmome” means Monitor function, “Alarm” means Emergency Alarm function.



Visit baofengradios.com for Download and Help

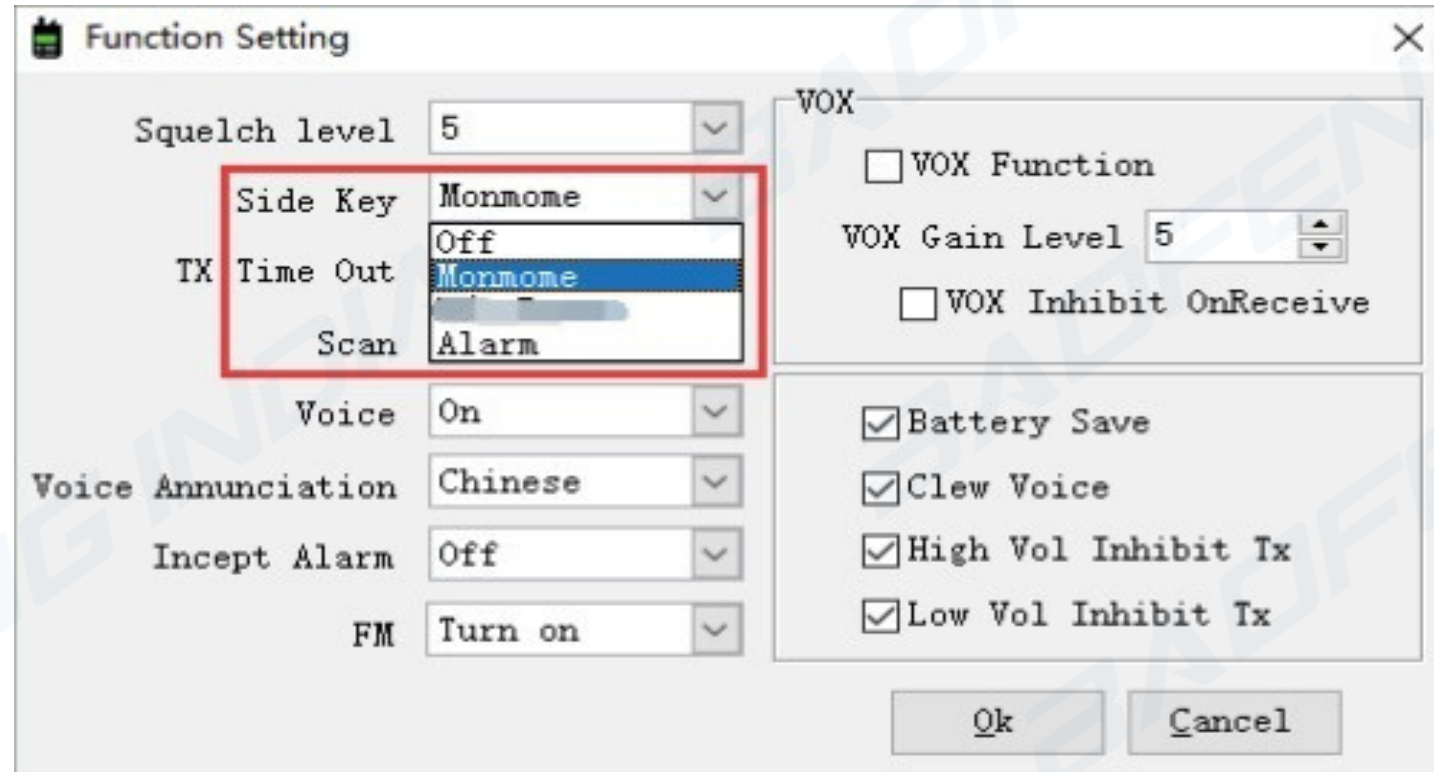

Monitor

This feature allows users to check whether a channel is clear before transmitting. If a frequency is in use, you can hear what is transmitting. It's important to check the frequency and privacy code you intend to use and select clear frequencies to set your channels. It's also helpful to use the radio when receiving a weak signal. Press and hold MONI button, the indicator light will turn green which indicates the radio is receiving signal.

Emergency Alarm

Emergency Alarm is used to indicate an emergency situation. When press and hold the Alarm key, it makes a loud alarm so that other people will know you are in trouble. You can initiate an emergency call at any time, even if there is activity on the current channel.



Visit baofengradios.com for Download and Help

Chapter 4 – Computer Programming

The Radio kit does not include a programming cable. To attain a PC cable please visit <https://baofengradios.com>

1. Computer System Requirements

Operating System: Windows 98, Windows Me, Windows XP, Windows 7, Windows 8 and Windows 10

Hard Disk Space: at least 50MB of available

The minimum memory: 64M

2. Programming Cable

A. USB programming cable - The driver needs to be installed before writing any frequencies.

1) Find the corresponding driver of the system

2) Click install and wait for the installation succeed.

B. If you are using a serial cable a driver is not required. You can just plug in and use directly.

3. Software Download & Install

1) Turn on computer, check if your computer system meets the requirements.

2) Download the programming software on radioddity.com

3) Install the programming software



Visit baofengradios.com for Download and Help

4. Connect your BF-9700/PMR446 with Computer

- 1) USB (or serial) programming cable connects with the computer end.
- 2) Connect the other end of the cable with your BF-9700/PMR446
- 3) When the both ends have been connected, turn on your radio. Make sure it has enough power during the programming procedure.

Note

In some cases, the cable does not fully seat in a new radio. Make sure the cable is FULLY seated prior to transferring data.

5. Read & Write Data via Software

- 1) In the software menu, click Setup> Communication Port and select proper COM port (COM port may be located by using Windows Device Manager).
 - 2) In the menu, Select Program> Read from Radio> OK to read frequencies. This process takes a few seconds and progress is shown by a green progress bar in the software.
 - 3) Now you can edit any data and set all the functions that you want.
 - 4) To write your completed data file, select Program> Write to Radio> OK.
 - 5) If you have to program multiple BF-9700 A/E's you can repeat the above steps.
6. If you have to program multiple walkie talkies, you can repeat the above steps.

FRS, GMRS, MURS and PMR446

You may be tempted to use FRS, GMRS, MURS (in the USA) or PMR 446 (In India) Frequencies. Do note however there are restrictions on these bands that make this transceiver illegal for use.



Visit baofengradios.com for Download and Help

Chapter 5 -- Trouble Shooting Guide

- 1) When reading or writing frequency, I do not get a response or it reports a communication error?
 - a. Check your programming cable to see if it is damaged.
 - b. Check the connection of the programming cable and computer serial port.
 - c. Check to find if the BF-9700/PMR446 battery level is low or depleted. If it is replace or charge the battery.
 - d. Check the programming software is matched with the current model.
 - e. Check if you turn ON your radio.
 - f. Check that the proper software drivers are properly installed.
- 2) When programming is done, why can't my two radios talk to each other?
 - a. Make sure the two radios are on the same channel.
 - b. Check the same channel is set to receive the same QT/DQT (CTCS / DCS).
 - c. Check if the two radios' volume control level is high enough. Depress the MON button and adjust volume to comfortable levels.
 - d. Check for proper installation of the antennas.
 - e. Check range of the radios (Line of Sight).



Visit baofengradios.com for Download and Help

3) Other often seen problems

<i>Troubles</i>	<i>Solution</i>
Radio cannot turn on	1. The battery is out of power. Replace or recharge the battery. 2. The battery is installed incorrectly. Remove it and install again
The operating time becomes short, even the battery is fully charged	Replace the battery.
Unable to communicate with the transceivers of the same group	1. Confirm the QT/DOT is the same 2. The distance is out of range
The voice of another group can be heard	Change all QT/DOT of the group
Other radios cannot receive the TX signals or receive signals in a low volume	1. Switch the volume knob to the highest 2. The microphone may be damaged, send it to the local dealer for checking
Noise is always heard	The distance is out of range Turn on the radio in shorter distance and try again



Visit baofengradios.com for Download and Help

Appendix A -- RF Energy Exposure and Product Safety Guide for Portable Two-way Radios

ATTENTION!

Before using this radio, read this guide which contains important operating instructions for safe usage and RF energy awareness and control for compliance with applicable standards and regulations.

This two-way radio uses electromagnetic energy in the radio frequency (RF) spectrum to provide communications between two or more users over a distance. It uses radio frequency (RF) energy or radio waves to send and receive calls. RF energy is one form of electromagnetic energy. Other forms include, but are not limited to, sunlight and x-rays. RF energy, however, should not be confused with these other forms of electromagnetic energy, which when used improperly, can cause biological damage. Very high levels of x-rays, for example, can damage tissues and genetic material.



Visit baofengradios.com for Download and Help

Experts in science, engineering, medicine, health, and industry work with organizations to develop standards for safe exposure to RF energy. These standards provide recommended levels of exposure for both workers and the general public. These recommended RF exposure levels include substantial margins of protection.

All Radioddity two-way radios are designed, manufactured, and tested to ensure they meet government established RF exposure levels. In addition, manufacturers also recommend specific operating instructions to users of two-way radios. These instructions are important because they inform users about RF energy exposure and provide simple procedures on how to control it.

Please refer to the following websites for more information on what RF energy exposure how to control your exposure to assure compliance with established RF exposure limits:

<http://www.who.int/en/>

Radio License

Governments keep the radios in classification, most of the classified walkie-talkie need to get local government License and operation is allowed. For the following specified classification: the USA FRS, EU PMR. Australian CB, the individual license is not required and in India PMR 446-446.20Mhz is Licence Free.



Visit baofengradios.com for Download and Help

RF energy exposure standards and guidelines (if appropriate)

Your Baofengradios two way radio complies with the following RF energy exposure standards and guidelines :

1. United States Federal Communications Commission (FCC), Code of Federal Regulations; 47 CFR part 2 sub-part J
2. American National Standards Institute (ANSI) Institute of Electrical and Electronic Engineers (IEEE) C95.1-2005
3. IEEE Std. 1528: 2013 and KDB447498, Evaluating Compliance with FCC Guidelines for Human Exposure to Radio Frequency Electromagnetic Fields
4. Institute of Electrical and Electronic Engineers (IEEE) C95.3-2002
5. International Commission on Non-Ionizing Radiation Protection (ICNIRP)
6. Ministry of Health (Canada) Safety Code 6 & Industry Canada RSS-102
7. International Electrotechnical Commission IEC 62209-2. 2010
8. Ministry of Communications in India G.S.R. 1047(E) dated October 18, 2018.



Visit baofengradios.com for Download and Help

Operating Instructions

1. Transmit no more than the rated duty factor of 50% of the time. To Transmit (Talk), push the Push To Talk (PTT) button to receive calls(listen), release the PTT button. Transmitting 50% of the time, or less, is important because the radio generates measurable RF energy exposure only when transmitting in terms of measuring for standards compliance.
2. Transmit only when people outside the vehicle are at least the recommended minimum lateral distance away from a properly installed according to installation instructions, externally mounted antenna.
3. When operating in front of the face, worn on the body, always place the radio in a Baofeng approved clip, holder, holster, case, or body harness for this product. Using approved body worn accessories is important because the use of Non-Radi-oddity approved accessories may result in exposure levels, which exceed the IEEE/ICNIRP occupational/controlled environment RF exposure limits.
4. If you are not using a body worn accessory and are not using the radio in the intended use position, in front of the face or at the body in the PTT mode or alongside of the head in the phone mode, then ensure the antenna and the radio are kept 2.5 cm (one inch) from the body when transmitting. Keeping the radio at a proper distance is important because RF exposures decrease with increasing distance from the antenna.



Visit baofengradios.com for Download and Help

Protect your hearing

1. Use the lowest volume necessary to do your job.
2. Turn up the volume only if you are in noisy surroundings.
3. Turn down the volume before adding headset or earpiece.
4. Limit the amount of time you use headsets or earpieces at high volume.
5. When using the radio without a headset or earpiece, do not place the radio's speaker directly against your ear.

Note: Exposure to loud noises from any source for extended periods of time may temporarily or permanently affect your hearing. The louder the radio's volume, the less time is required before your hearing could be affected. Hearing damage from loud noise is sometimes undetectable at first and can have a cumulative effect.

Safety Operation

Forbidden

1. Do not use charger outdoors or in moist environments, use only in dry locations/conditions.
2. Do not disassemble the charger, which may result in risk of electrical shock or fire.
3. Do not operate the charger if it has been broken or damaged in any way.
4. Do not place a portable radio in the area over an air bag or in the air bag deployment area. The radio may be propelled with great force and cause serious injury to occupants of the vehicle when the air bag inflates.



Visit baofengradios.com for Download and Help

To reduce risk

- 1.Pull by the plug rather than the cord when disconnecting the charger.
- 2.Unplug the charger from the AC outlet before attempting any maintenance or cleaning.
- 3.Contact Baofeng for assistance regarding repairs and service.

Use of Communication Devices While Driving

- 1.Always check the laws and regulations on the use of radios in the countries and areas where you drive.
- 2.Give your full attention to driving and to the road.
- 3.If available, use the hands-free facility.
- 4.If driving conditions or regulations require it, pull off the road and park before making or answering a call.



Visit baofengradios.com for Download and Help

Appendix B -- Specifications

General

Model Number	BF9700/PMR
Frequency range	IN:446-446.20
Channel Number	16
Working Voltage	DC 3.7V
Working Temperature	-10℃ ~+50℃
Antenna	Fixed Non Removal
Antenna Impedence	50Ω
Working Mode	Simplex

Receiver

Frequency range	US:FRS EU:PMR
Sensitivity	≤ 0.2uV
Occupied Bandwidth	<12.5Khz
Selectivity	≥ 65dB
Intermediation	≥ 55dB
Audio power	0.5W



Visit baofengradios.com for Download and Help

Audio distortion	≤ 5%
Frequency Stability	5ppm
Current	80mA(when standby) 220mA(when working)
Audio response	+7~-12.5dB

Transmitter

Frequency range	IN:446-446.20
Output power	0.5W
Modulation mode	16KF 3E
Spurious radiation	≤ 7.5uW
Modulation noise	<-40dB
Modulation distortion	<5%
Frequency Stability	5ppm
Maximum deviation	≤ ± 5KHz
Current	≤ 2300mA
Audio response(300-3000Hz)	+6.5~-14dB
Adjacent Ch. power	≥ 65dB
Intermediation sensitivity	8~12mv

Note: Specifications will be revised without notice due to technical improvement. Thank you.



Visit baofengradios.com for Download and Help

Contact Us:

Manufactured by:

Shopperclue Webtrade India Pvt. Ltd.
Unit 614, Tower B4, Spaze IT Park Sohna Road
Sector 49, Gurgaon Haryana 122018
Email: support@baofengradios.com
Mob. No. : +91-9810341423

Sales & Marketed By:

G.S. TeleCommunication Limited Unit
614A, Tower B4, Spaze IT Park Sohna Road
Sector 49, Gurgaon Haryana 122018
Email: support@baofengradios.com
Mob. No. : +91-9810341423