

**BAOFENG®**

**User Manual**

**FCC**

***k6 series***

***Amateur Radio***



## PREFACE

Thank you for purchasing this product. which is a dual band/dual display/dual watch. This easy-to-use radio will deliver you secure, instant and reliable communications at peak efficiency. Please read this manual carefully before use. The information presented herein will help you to derive maximum performance from your radio.



**WARNING!** European Users should note that operation of this unit in Transmit mode requires the operator to have a valid Amateur Radio License from their respective Countries Amateur Radio Licensing Authority for the Frequencies and Transmitter Power levels that this Radio transmits on. Failure to comply may be unlawful and liable for prosecution. At this subject, refer to the "EU" specification guide 2014/53/EU.



**ATTENTION!** When programming the radio, start by reading the factory software data, and then rewrite this data with your frequency etc., to a new saved code plug, otherwise errors may occur. You can use the programming cable with a PC to program the authorized frequency, bandwidth, power, etc. your programming must comply with your FCC (or EU other country) license certification.



**ATTENTION!** Before using this product, read the RF Energy Exposure and Product Safety Guide that ship with the radio which contains instructions for safe usage and RF energy awareness and control for compliance with applicable standards and regulation.



### **PMR446, FRS, GMRS, MURS**

You may be tempted to use PMR446 (in Europe) or FRS, GMRS, MURS (in the USA) frequencies. Do note however that there are restrictions on these bands that make this transceiver illegal for use.



## Table of Contents

### Chapter1. Getting Started

- 1.1 Regulations and Safety Warnings
- 1.2 Content of the packaging
- 1.3 Main features

### Chapter2. Charging the Battery

- 2.1 Charging the Battery Pack
- 2.2 Charger Supplied
- 2.3 Use Caution with the Li-ion Battery
- 2.4 How to Charge
- 2.5 LED Indicator

### Chapter3. Installation of Accessories

- 3.1 Installing/Removing the Antenna
- 3.2 Installing the belt clip
- 3.3 Installing the battery pack
- 3.4 Additional Speaker/Microphone (Optional)

### Chapter4. Radio Overview

- 4.1 Buttons and controls of the radio
- 4.2 Display of the radio
- 4.3 Status Indications
- 4.4 Main keypad controls

### Chapter5. Basic Operations

- 5.1 Power on the radio
- 5.2 Adjusting the volume

- 5.3 Main Band/Sub Band Select
- 5.4 VFO/Channel Switch
- 5.5 Frequency (VFO) mode
- 5.6 Channel (MR) mode and Channel selection
- 5.7 Making a call
- 5.8 Using the Flashlight
- 5.9 Emergency Alert
- 5.10 FM Radio
- 5.11 Monitor
- 5.15 One touch frequency Search

### Chapter6. Advanced Features

- 6.1 Working the menu system
- 6.2 Scanning
- 6.3 Manual Programming (Channels Memory)
- 6.4 Repeaters Programming
- 6.5 VOX
- 6.6 Dual Watch
- 6.7 Stopwatch timer
- 6.8 DTMF
- 6.9 Customization
- Appendix A. - Technical Specifications
- Appendix B. - Trouble shooting guide
- Appendix C. - Shortcut Menu operations



## Chapter1. Getting Started

### 1.1 Regulations and Safety Warnings

#### FCC Part15/ICCompliance

##### FCC Part 15 Compliance

This device complies with Part 15 of the FCC rules. Operation is subjected to the following two conditions: (1) this device may not cause harmful interference, and (2) this device must accept any interference received, including interference that may cause undesired operation. Changes or modifications not expressly approved by the party responsible for compliance could void your authority to operate the equipment. Avis de conformité à la FCC : Ce dispositif a été testé et s'avère conforme à l'article 15 des règlements de la Commission fédérale des communications (FCC). Ce dispositif est soumis aux conditions suivantes: 1) Ce dispositif ne doit pas causer d'interférences nuisibles et; 2) Il doit pouvoir supporter les parasites qu'il reçoit, incluant les parasites pouvant nuire à son fonctionnement. Tout changement ou modification non approuvé expressément par la partie responsable pourrait annuler le droit à l'utilisateur de faire fonctionner cet équipement.

##### IC Compliance

This device complies with Industry Canada license-exempt RSS standard(s). Operation is subject to the following two conditions: (1) this device may not cause interference, and (2) this device must accept any interference, including interference that may cause undesired operation of the device. Changes or modifications not expressly approved by the party responsible for compliance could void your authority to operate the equipment.

Cet appareil est conforme aux normes RSS exemptes de licences d'Industrie Canada. Son fonctionnement est soumis aux deux conditions suivantes : (1) cet appareil ne doit pas causer d'interférences nuisibles et (2), il doit pouvoir accepter les interférences, incluant celles pouvant nuire à son fonctionnement normal. Tout changement ou modification non approuvé expressément par la partie responsable pourrait annuler le droit à l'utilisateur de faire fonctionner cet équipement.



## **FCC RF Exposure**

WARNING! It is up to the user to properly operate this radio transmitter to insure safe operation. Please adhere to the following: Do not use the radio with a damaged antenna. If a damaged antenna comes into contact with the skin, a minor burn may result. Please contact your local dealer for a replacement antenna.

### **Hand-Held Operation (Held-to-Face)**

This device was evaluated for typical hand-held (held-to-face) operations with a 1 inch spacing from the front of the radio. For hand-held operation, the radio should be held 1 inch from the user's face in order to comply with FCC RF exposure requirements.

### **Body-Worn Operation**

This device was evaluated for body-worn operations with the supplied belt-clip accessory. (All necessary accessories are included in the package; any additional or optional accessories are not required for compliance with the guidelines.) Third party accessories (unless approved by the manufacturer) should be avoided as these might not comply with FCC RF exposure guidelines.

For body worn operation, this device has been tested and meets the Industry Canada RF exposure guidelines when used with our company accessories supplied or designated for this product. Use of other accessories may not ensure compliance with Industry Canada RF exposure guidelines.

Fonctionnement de l'appareil, lorsque porté sur le corps. Cet appareil a été testé et s'est avéré conforme aux normes d'Industrie Canada et approuvé pour le port sur le corps à l'aide des accessoires notre société inclus et conçus pour cet appareil. L'utilisation d'accessoires ne respectant pas les exigences d'exposition RF d'Industrie Canada doit être évitée.

## **Precautions for Portable Terminals**

### **Operating Prohibitions**

To protect you against any property loss, bodily injury or even death, be sure to observe the following safety instructions:

1. Do not operate the product in a location containing fuels, chemicals, explosive atmospheres and other flammable or explosive materials. In such location, only an approved Ex-protection model is allowed for use, but any attempt to assemble or disassemble it is strictly prohibited.



2. Do not operate the product near or in any blasting area.
3. Do not operate the product near any medical or electronic equipment that is vulnerable to RF signals.
4. Do not hold the product while driving.
5. Do not operate the product in any area where use of wireless communication equipment is completely prohibited.

## **Important Tips**

To help you make better use of the product, be sure to observe the following instructions:

1. Do not use any unauthorized or damaged accessory.
2. Keep the product at least 2.5 centimeters away from your body during transmission.
3. Do not keep the product receiving at high volume for a long time.
4. For vehicles with an air bag, do not place the product in the area over the air bag or in the air bag deployment area.
5. Keep the product and its accessories out of reach of children and pets.
6. Please operate the product within the specified temperature range.
7. Continuous transmission for a long time may lead to heat accumulation within the product. In this case, please keep it at a proper location for cooling.
8. Handle the product with care.
9. Do not disassemble, modify or repair the product and its accessories without authorization.

## **■ Precautions for Batteries**

### **Charging Prohibitions**

To protect you against any property loss, bodily injury or even death, be sure to observe the following safety instructions:

1. Do not charge or replace your battery in a location containing fuels, chemicals, explosive atmospheres and other flammable or explosive materials.
2. Do not charge your battery that is wet. Please dry it with a soft and clean cloth prior to charge.
3. Do not charge your battery suffering deformation, leakage and overheat.
4. Do not charge your battery with an unauthorized charger.
5. Do not charge your battery in a location where strong radiation is present.
6. Overcharge shall always be prohibited for it may shorten the life of your battery.

### **Maintenance Instructions**

To help your battery work normally or prolong its life, be sure to observe the following instructions:



1. Accumulated dust on charging connector may affect normal charging. Please use a clean and dry cloth to wipe it on a regular basis.
2. It is recommended to charge the battery under 5°C~40°C. Violation of the said limit may cause battery life reduction or even battery leakage.
3. To charge a battery attached to the product, turn it off to ensure a full charge.
4. Do not remove the battery or unplug the power cord during charging to ensure a smooth charging process.
5. Do not dispose of the battery in fire.
6. Do not expose the battery to direct sunlight for a long time nor place it close to other heating sources.
7. Do not squeeze and penetrate the battery, nor remove its housing.

### **Transportation Instructions**

1. Damaged batteries must not be transported.
2. To avoid short circuit, separate the battery from metal parts or from each other if two or more batteries are transported in one packaging.
3. The radio must be switched off and secured against switch-on, if the battery is attached. The content of the shipment must be declared in the shipping documents and by a Battery Shipping Label on the packaging. Contact your hauler for the local regulations and further information.

### **Maintenance**

Your Two Way Radio is an electronic product of exact design and should be treated with care.

The suggestions below will help you to fulfill any warranty obligations and to enjoy this product for many years.

- Do not attempt to open the radio for any reason! The radio's precision mechanics and electronics require experience and specialized equipment; for the same reason, the radio should under no circumstances be realigned as it has already been calibrated for maximum performance.

Unauthorized opening of the transceiver will void the warranty.

- Do not store the Radio under the sunshine or in hot areas.
- High temperatures can shorten the life of electronic devices, and warp or melt certain plastics.
- Do not store the radio in dusty and dirty areas.
- Keep the Radio dry. Rainwater or damp will corrode electronic circuits.
- If it appears that the Radio diffuses peculiar smell or smoke, please shut off its power immediately and take off the charger or battery from the radio.
- Do not transmit without antenna.





## Chapter2. Battery Information

### 2.1 Charging the Battery Pack

The Li-ion battery pack is not charged at the factory; please charge it before use. Charging the battery pack for the first time after purchase or extended storage (more than 2 months) may not bring the battery pack to its normal maximum operating capacity. Best operation will require fully charging/ discharging the battery two or three times before the operating capacity will reach its best performance. The battery pack life may be depleted when it's operating time decreases even though it has been fully and correctly charged. If this is the case, replace the battery pack.

### 2.2 Charger Supplied

Please use the specified charger provided by our company. Other models may cause explosion and personal injury. After installing the battery pack, and if the radio display slow battery with a voice prompt, please charge the battery.

### 2.3 Use Caution with the Li-ion Battery

- Do not short the battery terminals or throw the battery into a fire. Never attempt to remove the casing from the battery pack, as our company cannot be held responsible for any accident caused by modifying the battery.
- The ambient temperature should be between 5°C-40°C (40F - 105F) while charging the battery. Charging outside this range may not fully charge the battery.
- Please turn off the radio before inserting it into the charger. It may otherwise interfere with correct charging.
- To avoid interfering with the charging cycle, please do not cut off the power or remove the battery during charging until the green light is on.
- Do not recharge the battery pack if it is fully charged. This may shorten the life of the battery pack or damage the battery pack.
- Do not charge the battery or the radio if it is damp. Dry it before charging to avoid damage.



#### **WARNING!**

*When keys, ornamental chain or other electric metals contact the battery terminal, the battery may become damage or injure a human. If the battery terminals are short circuited it will generate a lot of heat. Take care when carrying and using the battery. Remember to put the battery or radio into an insulated container. Do not put it into a metal container.*



## 2.4 How to Charge

- Plug the AC adaptor into the AC outlet, and then plug the cable of the AC adaptor into the DC jack located on the back of the charger. The indicator light blinks orange and is then ready to charge a battery.
- Plug the battery or the radio into the charger. Make sure the battery terminals are good in contact with charging terminals. The indicator light turns to red--- charging begins.
- It takes approximately 2-5 hours to fully charge the battery. When the lamp lights green, the charging is completed. Remove the battery or the radio unit with its battery from socket.

*When charging a radio (with battery) the indicating lamp will not turn into green to show the fully charged status if the radio is powered on. Only when the radio is switched off will the lamp indicate normal operation. The radio consumes energy when it is power-on, and the charger cannot detect the correct battery voltage when the battery has been fully charged. So the charger will charge the battery in constant voltage mode and fail to indicate correctly when the battery has been fully charged.*

## 2.5 LED Indicator

STATUS	LED
No Battery	Green and red alternately flashing
Charge Normally	Red
Fully Charged	Green
Trouble	Red blinks fast for a long time

**NOTE:** *Trouble means battery too warm, battery short-circuited or charger short-circuited.*

## 2.6 How to Store the Battery

- If the battery needs to be stored, keep it in status of 80% discharged.
- It should be kept in low temperature and dry environment.
- Keep it away from hot places and direct sunlight.
  - » Do not short circuit the battery terminals.
  - » Never attempt to remove the casing from the battery pack.
  - » Never store the battery in unsafe surroundings, as a short may cause an explosion.
  - » Do not put the battery in a hot environment or throw it into a fire, as it may cause an explosion.



## 2.7 Using the Type-C USB Charger

The micro-USB charger is a handy port that allows you to conveniently charge your Li-ion battery pack.

1. Make sure your radio is turned OFF.
2. Plug the Type-C USB cable into the Type-C USB charging port on your battery. Connect the other end of the micro-USB charger to wall power outlet.
3. An empty battery will be fully charged in 4 hours.
4. The battery meter on LCD will move to indicate the battery is charging.

Note:

- It is recommended to power OFF your radio while charging. However, if power is turned on while charging, you may not be able to transmit a message if the battery is completely empty. Allow time for the battery to charge to 1 bar before attempting to transmit a message.
- For optimal battery life, remove the radio from the charger within 6 hours. Do not store the radio while connected to the charger.

## Chapter3. Installation of Accessories

Before the radio is ready for use we need to attach the antenna and battery pack, as well as charge the battery.

### 3.1 Installing/ Removing the Antenna

- Slide the battery into the radio frame unit the latch which is at the bottom of the radio clicks into place.
- To remove the battery, lift up the latch which is at the bottom of the radio, then slide the battery out from the radio.

#### NOTICE:

When removing the battery, ensure that the radio is turned off.

### 3.2 Installing the belt clip

- Align the grooves of the belt clip with those of the radio and push down until you hear a click.
- To remove the clip, use a flat bladed object to press the belt clip tab away from the radio. Then, slide the clip upward and away from the radio.

### 3.3 Installing the battery pack

Before attaching or removing the battery make sure your radio is turned off by turning the power/volume knob all the way counter-clockwise.

- Make sure the battery is aligned in parallel with the radio body with the lower edge of the battery about 1-2cm below the edge of the radio.
- Once aligned with the guide-rails, slide the battery upward until you hear a click as the battery locks in place.

#### Remove the battery pack

To remove the battery, press the battery release above the battery pack, as you slide the battery downward.

### 3.4 Installing the Additional Speaker/Microphone (Optional)

Try open the rubber MIC-Headset jack cover and then insert the Speaker / Microphone plug into the jack.

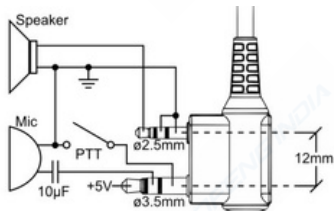

## Chapter4. Radio Overview

### 4.1 Buttons and controls of the radio

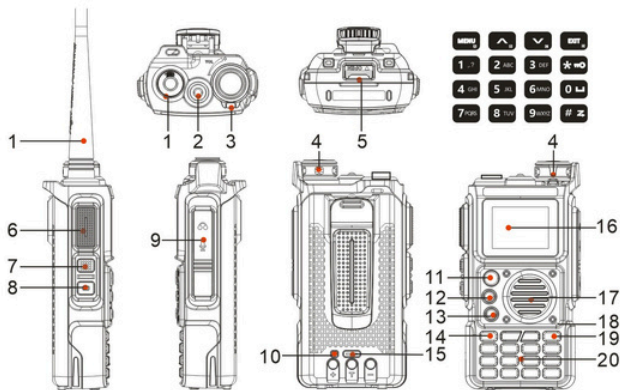

1. Antenna
4. Power / Volume knob
7. SK1-Programmable key (flashlight/alarm switch)
10. Type-C charging indicator
13. SWEEP key
16. Color LCD
19. EXIT Key

2. LED flashlight
5. Battery release latch
8. SK2-Programmable Key (Radio/Monitor)
11. V/M-VFO/MR mode key
14. MENU Key
17. Speaker
20. Keypad

3. Status LED
6. PTT - Push to talk
9. Accessory jack
12. A / B select key
15. Type-C charging port
18. Microphone



## 4.2 LCD Display

Icon	Description	Icon	Description
Mxxx	Memory channel	DW	Dual watch enabled
VFO	Frequency Mode	TX	Transmitting
VOX	VOX enabled	RX	Receiving
CTC	CTCSS enabled	R	Reverse function enabled
DCS	DCS enabled	□	Indicates active band or channel
N	Narrowband enabled	+/-	Frequency shift direction if enabled in VFO
H/L	Transmit power level indicator According to Power (High/Low)		Battery level indicator
			Squelch Open/ Close Indicator

Icon  
Mxxx  
VFO  
VOX  
CTC  
DCS  
N

## 4.3 Status Indications

The status LED has a very simple and traditional design. When you receive a signal it turns green, when you transmit it turns red, and it's off in standby.

LED Indicator	Radio Status
Constant Red	Transmitting
Constant Green	Receiving

## 4.4 Main keypad Controls

- V/M: Short press to switch between frequency mode and channel mode. Press and hold to toggle through channel display modes: CH/FREQ/NAME.
- A/B: Short press to toggle between the upper screen (A)/lower screen (B). Press and hold to switch Double Wait/ Signal Wait/ Dual Watch off modes.
- One-Touch search key: Press and hold to enter One-touch search mode.
- EXIT: Short press to return to menu or return to previous menu. (Press and hold to enter frequency sweep mode).
- : Long press to lock or unlock the keypad.
- : Short press to enter DTMF dial function. Press and hold to toggle scan on/off.
- 0[space] : Press and hold to enter the weather menu and select a weather channel.



- **[MENU] key:** Use to activate the MENU, select options, and confirm parameters.
- **▲ key:** Press and hold for more than 2 seconds to rapidly move the channel and frequency upwards. In SCAN mode, use this control to move the scanning upwards.
- **▼ key:** Press and hold for more than 2 seconds to rapidly move the channel and frequency downwards. In SCAN mode, use this control to move the scanning downwards.
  - **[EXIT] key**  
Press to exit the Menu and functions. Press and hold to activate the one-touch search function.

#### • **Numeric keypad**

Use these keys to input information or make selections on the radio. In TX mode, press the number keys to send corresponding DTMF codes.

#### **Programmed Key**

It is possible to set different functions for [SK1], [SK2] keys. Method: In radio Menu -48 /49/50: PF1 Press/PF1 Long Pre/ PF2 Press.

None	No Function
Torch On/Off	Quick switch torch
Power Select	Quickly switch between high, low transmit power
Scan On/Off	Quickly switch scanning function on or off
VOX On/Off	Quickly switch on/off VOX function
Alarm on/off	Quickly establishes an emergency call
Radio on/off	Quickly switch the FM radio function on or off



## Chapter5. Basic Operations

### 5.1 Power On the Radio

To turn the unit on, simply rotate the Volume/Power knob clockwise until you hear a "click". If your radio powers on correctly there should be an audible double beep after about one second and the display will show a message or flash the LCD depending on settings for about one second. Then it will display a frequency or channel. If the Voice prompt is enabled, the voice will announce "frequency mode" or "channel mode".

Turn the Volume/Power knob counter-clock wise all the way until you hear a "click". The unit is now off.

-Voice Prompt Setting: Press [MENU] to enter Menu>>30 VOICE.-

Power on Typ setting: press [MENU] to enter menu>>34 Power On Typ to select Picture, Message, Voltage.

-If there is a power-on password set, you need to enter the correct password. Press [MENU] to enter the menu >>37 Power-on

### 5.2 Adjusting the Volume

To turn up the volume, turn the volume/power knob clock-wise. To turn the volume down, turn the Volume/Power knob counter-clock-wise. Be careful not to turn it too far, as you may inadvertently turn your radio off.

By using the monitor function, enabled from the [FM broadcast/Monitor] key below the PTT, you can more easily adjust your volume by adjusting it to the un-squelched static.

### 5.3 Main Band/Sub Band Select

In standby mode, press the [A/B] key to to toggle between the upper screen (A)/lower screen (B). The frequency or channel on the selected display becomes the active listening and transmit frequency or channel.

*Press and hold the [A/B]key to quickly switch Double Wait/ Signal Wait/ Dual Watch off modes.*

### 5.4 VFO/Channel Mode Switch

Press the [V/M] key to switch between VFO and channel mode display.

- In channel mode (MR), the channel number will be displayed on the left.
- In frequency mode (VFO), the 'VFO' will be displayed on the left.

*In MR mode, Press and hold the [V/M] key to switch between frequency, channel, and name display modes.*



## 5.5 Frequency (VFO) Mode

In frequency (VFO) mode you can navigate up and down the band by using the  $\wedge/\vee$  keys. Each press will increment or decrement your frequency according to the frequency step you've set your transceiver to.

You can also input frequencies directly on your numeric keypad with kilohertz accuracy.

The following example assumes the use of a 12.5 kHz frequency step.

### **Example. Entering the frequency 436.61250 MHz on display A**

(1) In standby mode, press the [V/M] key to switch to the frequency (VFO) mode.

(2) Enter [4][3][6][6][1][2][5] [0] on the numeric keypad.

### **WARNING!**

Just because you can program in a channel does not mean you're automatically authorized to use that frequency. Transmitting on frequencies you're not authorized to operate on is illegal, and in most jurisdictions a serious offence. However, it is legal in most jurisdictions to listen.

Contact your local regulatory body for further information on what laws, rules and regulations apply to your area.

The scanning and receive function of the aviation frequency band (AM108-136MHz) and the police frequency band (350-390MHz) is limited to use in VFO mode and allows manual input of these frequencies. Prohibit use in channel mode.

## 5.6 Channel (MR) Mode and Channel Selection

There are two modes of operation: Frequency (VFO) mode, and Channel or Memory (MR) mode.

For everyday use, Channel (MR) mode is going to be a whole lot more practical than Frequency (VFO) mode. However, Frequency (VFO) mode is very handy for experimentation out in the field. Frequency (VFO) mode is also used for programming channels into memory.

In Channel (MR) mode you can navigate up and down the channel by using the  $\wedge/\vee$  keys or the encoder.

Ultimately which mode you end up using will depend entirely on your use case.

Press [V/M] key to switch the radio between VFO and Channel mode, select Channel mode.

- **Operation 1:** Press the  $\wedge/\vee$  navigation key to select the channel.
- **Operation 2:** Input the channel number using the keypad. For example, to switch to channel 12, enter [0][1][2]. The radio will then switch to channel 12.

*When the voice prompt function is enabled, the corresponding channel will be broadcast by voice.*



## 5.7 Making a Call

*NOTE: P Press the [A/B] key to switch the main channel to the other channel if two channels are shown on the display. In standby mode, press the [V/M] key to switch between frequency (VFO) mode and channel (MR) mode.*

- **Channel mode call:** After selecting a channel, hold down the [PTT] key to initiate a call. Speak into the microphone with a normal tone. When making a call, the red LED will be on.
- **Frequency mode call:** Press the [V/M] to switch to frequency mode, input the working frequency within the allowable range, and press and hold the [PTT] key to transmit on the current frequency. Speak into the microphone with a normal tone. When making a call, the red LED will be on.
- **Receive a call:** When you release the [PTT] key, you can receive incoming transmissions without any further action. When receiving a call, the green LED will be on.

*NOTE: To ensure optimal reception volume, maintain a distance of 2.5 cm to 5 cm between the microphone and your mouth during transmission.*

## 5.8 Using the Flashlight

You can use this radio in an emergency, press the [SK1] key to activate the high-intensity LED flashlight on your radio.

- Your radio functions normally while the emergency strobe is activated.
- (1) Press the [SK1] key once to activate the flashlight in Always On mode.
  - (2) Press the [SK1] key again to switch to Strobe Emergency mode, which emits an emergency signal.
  - (3) Press the [SK1] key once more to turn off the light.

## 5.9 Emergency Alert

The Emergency Alert feature signals for help within your group.

- (1) To activate the emergency alert function, press and hold the [SK1] key for 3 seconds. The radio will emit a loud siren and the flashlight will flash.
- (2) Press the [SK1] key again to exit the emergency alert function.

*WARNING: The Emergency Alert feature should only be used in the event of an actual emergency.*

## 5.10 FM Radio (FM)



The frequency range of the FM radio is 65-108 MHz.

(1) In frequency or channel mode, press the **[S K2]** key to turn on the FM radio.

(2) Select the desired radio frequency with the **▲/▼** keys or input the frequency. Or Press **[#Z]** to automatically search a radio station.

(3) Press the **[S K2]** key again to exit FM radio.

*Note: while you are listening to the radio, the frequency or channel of A / B receiving signal will automatically switch to the frequency or channel mode for normal transmitting and receiving.*

*When the signal disappears, the radio will automatically revert to FM radio mode.*

## 5.11 Monitor

In standby mode, press and hold the **[SK2]** key to enter Monitor. When receiving matched carrier but the signaling or the signal is too weak, this function allows monitor the weak signal. Release the **[SK2]** key to turn off the speakers and return to standby mode.

» If no signal, it will emit noise when press the **[SK2]** Key.

## 5.12 Keypad lock

The radio features a keypad lock that locks out all keys except for the three side keys. To enable or disable the keypad lock function, press and hold the key for about two seconds. You can also set the radio to automatically lock the keypad after ten seconds from the menu.

## 5.13 Frequency Reversal

Press the key to enable the reverse function key momentarily and you'll reverse your transmit and If you want to listen to the repeater's input frequency instead, press the key briefly to switch between transmit and receive frequencies

» After activating the frequency reversal function, the first line of the screen displays "R"

## 5.14 TX Repeater T one

Press the **[PTT] + [S K2]** keys to send a 1750Hz repeater tone. This function facilitates communication through repeaters. *If the keypad lock is enabled, you can still send the 1750Hz tone without unlocking the radio.*







## 5.15 One Touch Frequency Search

- (1) The radio will act as a receiver. Press and hold the  key, and the screen will display "SEARCH SWEET..."
- (2) If the transmitter continues to transmit and the unit detects a strong and stable signal, the received frequency will be displayed. If CTCSS or DCS is present, the corresponding value will be shown; if neither is detected, "NONE" will be displayed.
- (3) Press the [MENU] key to save the detected frequency and CTCSS or DCS to the channel.

*Note: During frequency search, press the  key on the radio to switch between UHF or VHF bands.*

## 5.16 Weather Radio/Scan Weather Channel

Your radio features a NOAA Weather Radio function, allowing you to receive weather reports from designated NOAA stations. It also includes a NOAA Weather Scan function, enabling you to scan all 10 NOAA Weather Radio channels for updates.

- (1) Press the [0] key for 3 seconds to turn on the NOAA Weather Scan function,  icon appears. The radio will go to weather band mode.
- (2) Press and hold the  key for 3 seconds to start automatic scanning of all 10 NOAA weather channels and stop on active channels. Press and hold the  key for 3 seconds again to stop the scan.
- (3) After stopping NOAA weather scan, it is allowed to manually select the weather channel by press the  key.
- (4) Press the [EXIT] key or [PTT] key to exit the weather radio broadcast mode.

### Weather channel frequencies and names

Channel Number	RX Frequency MHz	Channel Number	RX Frequency MHz
<b>Wx -01</b>	162.550	<b>Wx -06</b>	162.500
<b>Wx -02</b>	162.400	<b>Wx -07</b>	162.525
<b>Wx -03</b>	162.475	<b>Wx -08</b>	161.650
<b>Wx -04</b>	162.425	<b>Wx -09</b>	161.775
<b>Wx -05</b>	162.450	<b>Wx -10</b>	163.275

*NOTE: Weather Channels Wx-01 to Wx-10 are receive-only channels for NOAA and Canadian weather broadcasts. Transmission is not possible on these channels.*



## Chapter6. Advanced Features

### 6.1 Working the Menu System

#### 6.1.1 Basic Use

##### Using the menu with arrow keys

1. Press the [MENU] key to enter the menu.
2. Press the  $\wedge/\vee$  keys to navigate between menu items.
3. Once you find the desired menu item, press [MENU] again to select it.
4. Use the  $\wedge/\vee$  keys to select the desired parameter.
5. Once you've selected the parameter for a menu item;
  - a. Press the [MENU] key to confirm your selection. This will save the setting and return you to the main menu,
  - b. Press the [EXIT]key to cancel the changes. This will reset the menu item and exit the menu.
6. To exit the menu at any time, press the [EXIT]key .

#### 6.1.2 Using Short-Cuts

As detailed in Appendix B, Menu Definitions, each menu item has a corresponding numerical value for direct access. The menu is organized with the ten most common functions listed at the top for ease of use. Additionally, parameters are assigned numbers, which are also outlined in Appendix B for reference.

##### Using the menu with short-cuts

1. Press the [MENU] key to enter the menu.
2. Use the numerical keypad to enter the number of the menu item.
3. Press the [MENU]key to enter the menu item.
4. To enter the desired parameter, you have two options:
  - a. Use the arrow keys as described in the previous section;
  - b. Use the numerical keypad to enter the numerical short-cut code.
5. And just as in the previous section;
  - a. To confirm your selection, press the [MEN U]key and it will save your setting and return to the main menu.



- b. To cancel your changes, press the **[EXIT]** key and it will reset the menu item and exit the menu.
6. Press the **[EXIT]** key to exit the menu at any time.
7. All further examples and procedures in this manual will use the numerical menu shortcuts.

## 6.2 Scanning

The Radios features a built in scanner for the VHF and UHF bands. When in Frequency (VFO) mode, it will scan in steps according to your set frequency step. In Channel (MR) mode, it will scan your channels. At approximately, three frequencies per second, it may not be the fastest scanner, but it is still a useful feature. Note that Dual Watch is inhibited while scanning.

To enable the scanner, press and hold the **#2** key for about two seconds. Press and hold the **#2** key again to exit scanning mode.

### 6.2.1 Scanning Modes

The scanner is configurable to one of three ways of operation: Time, carrier or search, each of which is explained in further details in their respective section below.

#### Setting scanner mode

1. Press the **[MENU]** key to enter the menu.
2. Enter 1 9 on your numeric keypad to come to scanner mode.
3. Press the **[MENU]** key again to select.
4. Use the **^**/**v** keys to select scanning mode.
5. Press the **[MENU]** key again to confirm and save.
6. Press the **[EXIT]** key to exit the menu.

#### Time operation

In Time Operation (TO) mode, the scanner stops when it detects a signal, and after a factory preset time out, it resumes scanning.

#### • Carrier operation

In Carrier Operation (CO) mode, the scanner stops when it detects a signal, and after a factory preset time with no signal, it resumes scanning.

#### • Search operation

In Search Operation (SE) mode, the scanner stops when it detects a signal.

You must press and hold the **#2** key again to resume scanning.

### 6.2.2 Frequency Scanning

This function can scan the frequency.





- In frequency mode, press the key for more than 2 seconds. The radio will start scanning the frequency according to the set frequency step.
- You can change the scanning direction with the / keys.
- Press the key to stop the scanning.

*Note: for Scan mode, see Menu No.19.*

### 6.2.3 Channel Scanning

This function can scan the channels.

- In channels mode, press the key for more than 2 seconds. The radio will start scanning according to the channel you set.
- You can change the scanning direction with the  keys.
- Press the  key to stop scanning .

**Note: for Scan mode, see Menu No.19.**

### 6.2.4 Scan CTCSS

The function allows scanning the frequencies with CTCSS tone enabled. a. In standby mode, press the [MEN U]key, then press numeric keypad [1] [6], “Scan C TCSS” will appear on the display. b. Press the [MEN U] key to star the scan of CTCSS tones.

*NOTES: The function cannot be activated when the radio is set in Channel mode. The Scan will start only when the receiving band will detect a signal.*

### 6.2.5 Scan DCS

This function allows scanning the frequencies with DCS code enabled.

- In standby mode, press the [MEN U]key, then press numeric keypad[1][7]; the display will show “Scan DCS”.
- Press the [MEN U]key to star the scan of DCS codes.

*NOTES: The function cannot be activated when the radio is set in Channel mode. The Scan will start only when the receiving band will detect a signal.*

## 6.3 Manual Programming (Channels Memory)

Memory channels are an easy way to store commonly used frequencies so that they can easily be retrieved at a later date. The radios features 999 memory channels that each can hold: Receive and transmit frequencies, transmit power, group signaling information, bandwidth, ANI/ PTT-ID settings and a six-character alphanumeric identifier or channel name 1.

### Frequency Mode vs. Channel Mode



In standby mode, press [V/M] key to switch between frequency (VFO) mode and channel (MR) mode.

These two modes have different functions and are often confused.

**Frequency Mode (VFO):** Used for a temporary frequency assignment, such as a test frequency or quick field programming, if permitted.

**Channel Mode (MR):** Used for selecting preprogrammed channels.

### Ex 1. Programming a Channel Repeater Offset with CTCSS Tone

EXAMPLE New memory in Channel 10:

RX = 432.55000 MHz

TX = 437.55000 MHz (This is a (+ 5) Offset)

TX CTCSS tone 123.0

a. Press the [EXIT] key to switch between menus.

b. Press [V/M] key to set the radio to VFO mode, and the VFO icon is displayed on the left.

c. [MENU] [1][4] [MENU] [1] [0] [MENU] [EXIT]

Deletes Prior Data in channel (Ex. 10)

d. [MENU] [0][5] [MENU] 123.0 [MENU] [EXIT]

Selects desired TX encode tone

e. Enter RX frequency (Ex. 43255000)

f. [MENU] [1][3] [MENU] [1][0] [MENU]

Enter the desired channel (Ex 10)

-->[EXIT]

RX has been added

g. Enter TX frequency (Ex. 43755000)

h. [MENU] [1][3] [MENU] [1][0] [MENU]

Enter the same channel (Ex 10)

--> [EXIT]

TX has been added

i. Press [V/M] key to return to the MR mode and the channel number will reappear.

### Ex 2. Programming a Simplex Channel with CTCSS tone

EXAMPLE New memory in Channel 10:

RX = 432.6625 MHz

TX CTCSS tone 123.0

a. Press the [EXIT] key to switch between menus.

b. Press [V/M] key to set the radio to VFO mode, and the VFO icon is displayed on the left.

c. [MENU] [1][4] [MENU] [1] [0] [MENU] [EXIT]

Deletes Prior Data in channel (Ex. 10)



d. [MENU] [0][5] [MENU] 123.0 [MENU] [EXIT]

Select desired TX encode tone (Ex 123 CTCSS)

-->>Use [EXIT] to select Upper display

e. Enter RX frequency (Ex. 43266250)

Enter the desired channel (Ex 10)

f. [MENU] [1][3] [MENU] [1][0] [MENU]

Channel has been added

-->> [EXIT]

g. Press [V/M] key to return to the MR mode and the channel number will reappear.

## 6.4 Repeaters Programming

The following instructions assume that you know the transmit and receive frequencies your repeater uses and that you're authorized to use it.

a. Press the[V/M]key to set the radio to VFO mode, and the VFO icon is displayed on the left.

b. Use the numeric key pad to enter the repeater's output (your receiving) frequency.

c. Press the [MENU] key to enter the menu.



d. Enter[1][2]on the numeric keypad to get to the frequency offset.

e. Press the[MENU]key to select.

f. Use the numerical key pad to enter the specified frequency offset. See the section called "12OFFSET-Frequency shift amount" for details.

g. Press the[MENU]key to confirm and save.

h. Enter[1][1]on the numeric key pad to get to offset direction.

i. Use the   keys to select+(positive)or-(negative) offset.

j. Pres the[MENU]key to confirm and save.

k. Optional:

a). Save to memory, see the section called "Manual programming" for details.

b). Setup CTCSS; see the section called "CTCSS" for details.

l. Pres the[EXIT]key to exit the menu. If everything went well, you should be able to make a test call through the repeater.

### NOTE

*If you're experiencing problems making a connection to the repeater, check your settings and/or go through the procedure again.*

*Certain Amateur Radio repeaters (especially in Europe) use a 1750Hz tone burst to open up the repeater. To see how this is done with the radios, see the section called "1750Hz Tone-burst".*

*If you're still unable to make a connection, contact the person in charge of the radio system with your employer or your local amateur radio club, as the case maybe. If you want to listen to the repeater's input frequency instead, press the  key momentarily to reverse your transmit*

*and receive frequencies.*



*This is indicated in the LCD on the radio with an R in the top row, next to the + and - for the offset direction.*

## 6.5 VOX

This function allows hands-free conversations: just speak in the direction of the microphone and the communication will be automatically activated. In standby mode, press the **[MEN U]**key, then press numeric keypad **[2][5]**. The screen will display “**VOX Switch**”.

Press the **[MEN U]**key to enter the VOX function. Press the **▲/▼** keys to turn off/ turn on the VOX function

In standby mode, press the **[MEN U]**key, then press numeric keypad **[2][6]**. The screen will display “**VOX Level**”.

Press the **[MEN U]**key to enter this function. Press the **▲/▼** keys to select the VOX level (1-9), then press the **[M EN U]**key to confirm.

Press the **[EXIT]**key to return to the standby mode .

*NOTE: level 1 is the least sensitive while level 9 is the most sensitive. When the radio is in Scan or FM Radio mode, the VOX is not enabled.*

## 6.6 Dual Watch

In certain situations, the ability to monitor two channels at once can be a valuable asset. This can be achieved in one of two ways. You can either have one receiver in your radio and flip-flop between two frequencies at a fixed interval (known as Dual Watch), or you can equip a radio with two receivers (known as Dual Receive or Dual VFO). The former method is cheaper to implement and far more common than the latter. The Radios features Dual Watch functionality (single receiver) with the ability to lock the transmit frequency to one of the two channels it monitors.

### Enabling or disabling dual watch mode

1. Press the **[MENU]**key to enter the menu.
2. Enter 3 8 on the numeric keypad to get to **Dual Watch**.
3. Press the **[MENU]**key to select.
4. Use the **▲/▼** keys to choose between Double Wait/ Signal Wait/ OFF functions.
5. Press the **[MENU]** key to confirm.
6. Press the **[EXIT]** key to exit the menu.

## 6.7 Stopwatch Timer

In stand by mode, press the **[MEN U]**key, then press numeric keypad **[5][7]**. T he screen displays “**STOP WATCH**”.



# Visit [baofengradios.com](http://baofengradios.com) for Download and Help

Press the [MENU] key to enter this function. Press the  $\wedge/\vee$  keys to enable (ON) it, then press the [MENU] key again to confirm  
Press the [MENU] key to enter this function. Press the

Using the stopwatch timer:

When this function is ON, press the [MENU] key to start counting; Press the [MENU] key again to re-start counting. To exit the function, stop the counting first, and then press the [EXIT] key.

## 6.8 DTMF

DTMF is an in-band signaling method using dual sinusoidal signals for any given code. Originally developed for telephony systems, it has proved a very versatile tool in many other areas.

In two-way radio systems, DTMF is most commonly used for automation systems and remote control. A common example would be in amateur radio repeaters where some repeaters are activated by sending out a DTMF sequence (usually a simple single-digit sequence).

### DTMF frequencies and corresponding codes

	1209Hz	1336Hz	1477Hz	1633Hz
697Hz	1	2	3	A
770Hz	4	5	6	B
852Hz	7	8	9	C
941Hz	*	0	#	D

The radios has a full implementation of DTMF, including the A, B, C and D codes.

The numerical keys, as well as the  $\star$  and  $\#$  keys, correspond to the matching DTMF codes as you would expect. The A, B, C and D codes are located in the [MENU],  $\wedge/\vee$  and [EXIT] keys respectively.

To send DTMF codes, press the key(s) corresponding to the message you want to send while holding down the PTT key.

*If you have the keypad lock enabled on your radio, you can still send DTMF tones the regular way without having to unlock your radio.*

## 6.9 Customization

The radio allows you to define visual and audible features such as Display Illumination Time, MR/Channel Mode Display Format, Power On Message, Power On password, Keypad Beep, Roger Beep, Voice Prompt, etc. to suit your usage habits.

### 6.9.1 Display Backlight (ABR) - MENU 51

In stand by mode, press the [MENU] key, then press numeric keypad [5] [1]. The screen will display "ABR".



Press the [MENU]key to enter this function. Press the  keys to select the backlight mode: always on/ required delay time(ON/5sec/ 10sec/15sec /20sec) , then press the [MENU]key to confirm your selection. To return to the standby mode, press the [EXIT]key.

## 6.9.2 Beep PROMPT (BEEP) - MENU 32

If you enable this function, every time a key is pressed, you will hear a Beep tone.

In standby mode, press the [MENU]key, then press numeric keypad[3][2]. The screen will display “BEEP PROMPT”.

Press the [MENU] key to enter this function. Press the  keys to turn ON/OFF the beep function .

Press the [MENU] key to confirm and exit to return to stand-by mode.

## 6.9.3 Voice Function (VOICE) - MENU 30

In stand by mode, press the[MEN U]key, then press numeric keypad[3][ 0]; the screen will display “VOICE”.

Press the [MENU] key to enter this function. Press the  keys to turn ON/OFF the VOICE function.

Press the [MENU] key to confirm and press t he [EXIT] key to return to the standby mode.

## 6.9.4 Language of the MENU (LANGUAGE) - MENU 29

This section shows the language of the MENU (English).

In stand by mode press the [MEN U] key, then press numeric keypad [2][9]. The display will show “LANGUAGE”.

## 6.9.5 Working Mode (MDF-A) - MENU 39

The radio has four working modes available:

- Frequency mode (FREQ)
- Channel mode (CH)
- Channel name (NAME)

To shift from one mode to another one:

In Standby mode press the [MENU]key, then n press numeric keypad[3][9]; select the desired working mode by pressing the  keys. [MENU] key again to confirm your selection.

## 6.9.6 Roger Beep, end Transmission Tone (ROGER) - MENU 33

Roger Beep can be enabled/disabled:

- OFF: Roger Beep disabled



- BEEP: Roger Beep tone at the end of transmission In standby mode, press the [MEN U]key, then press numeric keypad[3][3 ]; the screen will display "ROGER". Press [MENU] to enter this function. Press the  $\wedge$   $\vee$  keys to select OFF/ON. Press the [MENU]key again to confirm y our selection. Press the [EXIT] key to return to the standby mode.

## 6.9.7 Power On Message (POWER ON MSG) - MENU 40

With this Menu you can customize the welcome message that appears on the display when the radio is switched on.

Choose amongst the following options: • VOLTAGE (the power voltage is momentarily displayed)

- MESSAGE (welcome message)
- LOGO (Custom Pictures)

In Standby mod, press t he [MENU] key, then press numeric keypad[4 ][0] .The display will show "POWER ON MSG".

Press [MENU] key to enter the function. Press the  $\wedge$   $\vee$  keys to select the desired option and confirm with MENU To return to the standby mode, press the [EXIT] key

## 6.9.8 Power On Password (Power On PWD) - Menu 37

With this Menu you can request the correct password when the radio is turned on. In standby mode, press the [MENU] key, then press numeric keypad [3][7]. The display will show "POWER ON PWD"

Press [MENU] key to enter the function. Press the  $\wedge$ / $\vee$  keys to enable/disable (ON/OFF) the power on password, Press the [MENU] key again to Confirm your selection. To return to standby mode, press the [EXIT]key.

*Enable the power on password function. Each time the radio is turned on, it will display "Input Password" to prompt for the correct password.*

*The default startup password is 000000*

## 6.10 Reset - MENU 56

This transceiver has two reset modes available: VFO and ALL.

- Reset VFO: all the settings except channels will return to the default settings.
- Reset ALL: all settings will return to the default settings.

### Reset VFO

In standby mode, press the [MEN U]key, then press numeric keypad[5] [6]; the screen will display "RESET".



Press **[MENU]** to enter this function. Press the **▲/▼** keys to select VFO, then press the **[MEN U]** key to confirm.

The display will show "Sure to reset? ". Press **[MENU]** again to confirm and the screen will display "Wait...". Then, the transceiver will turn off and reboot again.

## Reset ALL

In standby mode, press the **[MENU]** key, then press numeric keypad **[5][6]**. The screen displays "RESET".

Press **[MENU]** to enter this function. Press the **▲/▼** keys to select ALL, then press **[MENU]** to confirm.

The display will show "Sure to reset? ". Press **[MENU]** again to confirm; the screen will display "Wait...". Then, the transceiver will turn off and reboot again.

## Appendix A. – Trouble shooting guide

Phenomena	Analysis	Solution
You cannot turn on the radio.	The battery may be installed improperly.	Remove and reattach the battery
	The battery power may run out	Recharge or replace the battery.
	The battery may suffer from poor contact caused by dirty or damaged battery contacts.	Clean the battery contacts or replace the battery
During receiving, the voice is weak or intermittent.	The battery voltage maybe low	Recharge or replace the battery
	The volume level may be low	Increase the volume.
	The antenna maybe loose or maybe installed incorrectly	Turnoff the radio, and then remove and reattach the antenna.
You cannot communicate with other group members.	The speaker maybe blocked	Clean the surface of the speaker
	The frequency or signaling type maybe inconsistent with that of other members	Verify that your TX/RX frequency and signaling type are correct
You hear unknown voices or noise.	You may be too far away from other members	Move towards other members
	You may be interrupted by radios using the same frequency	Change the frequency, or adjust the squelch level
You are unable to hear anyone because of too much noise and hiss.	The radio in analog mode maybe set with no signaling	Request your dealer to set signaling for the current channel to avoid interference
	You may be too far away from other members	Move towards other members.
The radio keeps transmitting.	You may be in an unfavorable position. For example, your communication may be blocked by high buildings or blocked in an underground area.	Move to an open and flat area, restart the radio, and try again.
	It may be the result of external disturbance (such as electromagnetic interference).	Stay away from equipment that may cause interference
	VOX may be turned on or the headset is not installed in place	Turn off the VOX function. Check that the headphones are in place.

**NOTE: If the above solutions cannot fix your problems, or you may have some other queries, please contact your dealer for more technical support.**



## Appendix B. - Technical Specification

Frequency band	Scan Receiver: FM65-108MHz;AM108-136MHz,VHF136-174MHz, 220-260MHz,UHF 350-390MHz, 400-520MHz Transmission: 144-148&420-450MHz (Americaversion) 144-148 &430-450MHz (Canadian version)
Memory channels	999
Power supply Operating	batteria Li-Ion da 7.4V/2600 mAh
temperature Working	-10°C to +45°C
mode	monoband/dual band
Modulation	F3E(FM)
Max. frequency deviation	≤ ±5KHz
Spurious radiation	< -60dB
Frequency stability	±2.5 ppm
Rx sensitivity	< 0.2uV
Audio output power	≥ 500mW
Dimensions	64x121x35mm (LxAxP)
Weight	240g

*Specifications are subject to change without notice.*

**WARNING. Direct plug-in ac/dc power supply must be used for disconnecting the transceiver from the mains; the desktop charger must be positioned close to the unit and easily accessible.**



## Appendix C. - Shortcut Menu operations

MENU	Name (Full Name)	Settings	Description
00	CHL Name	CH-1	Set the alias of the channel. 1 to 16 characters (one Chinese character takes up two characters)
01	RX Frequency	430.00000	Displays the current received frequency and allows the frequency to be reset
02	TX Frequency	430.00000	Displays the current transmit frequency and allows the frequency to be reset
03	R-CTCS - Receiver CTCSS	OFF   see CTCSS Table in Appendix C	Mutes the speaker of the transceiver in the absence of a specific and continuous sub-audible signal. If the station you are listening to does not transmit this specific and continuous signal, you will not hear anything
04	R-DCS - Receiver DCS	OFF   see DCS Table in Appendix C	Mutes the speaker of the transceiver in the absence of a specific low-level digital signal. If the station you are listening to does not transmit this specific signal, you will not hear anything
05	T-CTCSS - Transmit CTCSS	OFF   see CTCSS Table in Appendix C	Mutes the speaker of the transceiver in the absence of a specific and continuous sub-audible signal. If the station you are listening to does not transmit this specific and continuous signal, you will not hear anything.
06	T-DCS - Transmit DCS	OFF   see DCS Table in Appendix C	Mutes the speaker of the transceiver in the absence of a specific low-level digital signal. If the station you are listening to does not transmit this specific signal, you will not hear anything.
07	Band Width - Wideband/Narrowband	WIDE   NARR	Wideband (25 kHz bandwidth) or narrowband (12.5 kHz bandwidth).
08	TXP -Transmit Power	HIGH LOW	Selects between HIGH and LOW transmitter power when in VFO/Frequency mode. Use the minimum transmitter power necessary to carry out the desired communications.
09	Silence Mode	CTDCS   CTDCS * Signal	
10	TX Forbid	OFF ON	
11	Shift DIR	<ul style="list-style-type: none"> <li>•OFF [0]: TX = RX (simplex)</li> <li>•+ [1]: TX will be shifted higher in frequency than RX</li> </ul>	Enables access of repeaters in VFO/Frequency Mode



# Visit [baofengradios.com](http://baofengradios.com) for Download and Help

		<ul style="list-style-type: none"> <li>• - [2]: TX will be shifted lower in frequency than RX</li> </ul>	
12	OFFSET	00.000, ..., 99.999	Specifies the difference between the TX and RX frequencies
13	MEMCH	001, ..., 999	This menu is used to either create new or modify existing channels (001 through 999) so that they can be accessed from MR/Channel Mode
14	DELCH	001, ..., 999	This menu is used to delete the programmed information from the specified channel (001 through 999) so that it can either be programmed again or be left empty.
15	VFO FreqRang	Upper/Lower	Setting the upper and lower limits of the scanning frequency range
16	Scan CTCSS	67.0HZ, ..., 254.1HZ	Scanning automatically stops when it receives the corresponding analogue CTCSS signal and turns on the speaker
17	Scan DCS	OFF, D023N, ..., D754I	Scanning automatically stops when it receives the corresponding analogue DCS signal and turns on the speaker
18	CDCSS SAVE	<ul style="list-style-type: none"> <li>• ALL: Saved in Transmit and Receive CTDS.</li> <li>• RX: Saved only in the receiving CTDS.</li> <li>• TX: Saved only in the transmitting CTDS.</li> </ul>	Saving scanned CTCSS and DCS.
19	Scan Mode	<ul style="list-style-type: none"> <li>• TO: Time Operation - scanning will resume after a fixed time has passed</li> <li>• CO: Carrier Operation - scanning will resume after the signal disappears</li> <li>• SE: Search Operation - scanning will not resume</li> </ul>	Scanning Resume Method
20	DTMFST	<ul style="list-style-type: none"> <li>• OFF : No DTMF Side Tones are heard</li> <li>• DT-ST: Side Tones are heard only from manually keyed DTMF codes</li> <li>• ANI-ST: Side Tones are heard only from automatically keyed DTMF codes</li> <li>• DT+ANI: All DTMF Side Tones are heard</li> </ul>	Determines when DTMF Side Tones can be heard from the transceiver speaker.



# Visit [baofengradios.com](http://baofengradios.com) for Download and Help

21	PTT ID	<ul style="list-style-type: none"> <li>•OFF: No ID is sent</li> <li>•BOT: The selected S-CODE is sent at the beginning</li> <li>•EOT: The selected S-CODE is sent at the ending</li> <li>•BOTH: The selected S-CODE is sent at the beginning and ending</li> </ul>	When to Send PTT-ID Codes are sent during either the beginning or ending of a transmission.
22	PTT-LT	0 100 200 400 600 800 1000ms	PTT-ID Delay (milliseconds)
23	Squelch - Squelch Level	[0 - 9] Setting the squelch to 0 will open up the squelch entirely.	Squelch silences the receiver when there is no signal. - Sensitivity can be varied from .1 to .3 mV on UHF Sensitivity can be varied from .1 to .2 mV on VHF
24	RX Save	OFF   1:1   1:2   1:4	Selects the ratio of sleep cycles to awake cycles (1:1, 2:1, 3:1, 4:1). The higher the number the longer the battery lasts. The higher number increases the RX sleep cycle, but you may miss the first few syllables before the RX opens.
25	VOX Switch	OFF ON	When enabled it is not necessary to press the [PTT] key on the transceiver.
26	VOX Level	1,2,... 9	Adjust the gain level to an appropriate sensitivity to allow smooth transmission.
27	VOX Delay	0.5sec, ...2.0sec	After the VOX function is enabled and the user ceases to speak, the radio will remain in TX mode for the period of time defined here.
28	TX Over Time	OFF 15,30,...180S	This feature provides a safety switch that limits transmission time to a programmed value. This will promote battery conservation by not allowing you to make excessively long transmissions, and in the event of a stuck PTT switch it can prevent interference to other users as well as battery depletion.
29	Language	E NGLISH中文	Set the language type of menu and prompt voice. •ENGLISH: Display as an English menu with English prompts for operation. •Chinese: Display as a Chinese menu and prompt for operation in Chinese.
30	VOICE	OFF [0]   ON [1]	Allows audible voice confirmation of a key press



# Visit [baofengradios.com](http://baofengradios.com) for Download and Help

31	Menu HangTim	5,10,15.....50Sec	Defines the time between entry and exit of the menu. The counter is activated after the radio enters menu operation. If there is no physical operation of the radio until the counter expires, the radio will exit the menu.
32	BEEP PROMPT	OFF   ON	Allows audible confirmation of a key press
33	Roger Beep	OFF BEEP Tone1200	Sends an end-of-transmission tone to indicate to other stations that the transmission has ended.
34	Power On Typ	<ul style="list-style-type: none"> <li>•LOGO: Predefined Logo.</li> <li>•MESSAGE: Preset messages are displayed at power-up. The power-up message can be edited via menu 36.</li> <li>•VOLTAGE: Battery voltage displayed at power-on: e.g. DC 8.2V, 100%</li> </ul>	Controls the behavior of the display when the transceiver is turned on.
35	Power On Ton	<ul style="list-style-type: none"> <li>•None: No power-on tone</li> <li>•Tone: Beep at power on</li> <li>•Voice: Welcome voice prompt at power on</li> </ul>	Setting the beep sound at power on
36	Power On MSG	WELCOME	Allows customisation of the start-up message at this radio. Press EXIT to delete forward and enter text or letters via the keypad.
37	Power On PWD	<ul style="list-style-type: none"> <li>•OFF: Disable the power-on password.</li> <li>•ON: Enable the power-on password.</li> </ul>	Enable power-on password function, power-on password is programmed by CPS software
38	Dual Watch	<ul style="list-style-type: none"> <li>•OFF: Disable the Dual Watch function to display only the channel number and frequency of the working channel.</li> <li>•Double Wait: Monitor [A] and [B] at the same time. The display with the most recent activity ([A] or [B]) becomes the selected display.</li> <li>•Signal Wait: Display [A] and [B] simultaneously. Monitor only the main band [A] or [B].</li> </ul>	Monitor [A] and [B] at the same time. The display with the most recent activity ([A] or [B]) becomes the selected display.
39	MDF-A	<ul style="list-style-type: none"> <li>•FREQ: Displays programmed Frequency</li> <li>•NAME: Displays the channel name.</li> <li>•CH: Displays the channel number</li> </ul>	[A] MR/Channel Mode Display Format Note: Note: Names are allowed to be entered in MENU 1 of the unit or using the software.
40	MDF-B	<ul style="list-style-type: none"> <li>•FREQ: Displays programmed Frequency</li> <li>•NAME: Displays the channel name.</li> <li>•CH: Displays the channel number</li> </ul>	[B] MR/Channel Mode Display Format Note: Note: Names are allowed to be entered in MENU 1 of the unit or using the software.



41	RP_STE	OFF 1s,2s,3s... 10s	This function is used eliminate squelch tail noise when communicating through a repeater.
42	RPT-RL	OFF 1s,2s,3s... 10s	Delay the Tail Tone of Repeater (X100 milliseconds)
43	ALERT- 1750Hz Tone-burst	<ul style="list-style-type: none"> <li>•1000Hz: PTT + SK1 = Transmits 1000Hz Tone Burst</li> <li>•1450Hz: PTT + SK1 = Transmits 1450Hz Tone Burst</li> <li>•1750Hz: PTT + SK1 = Transmits 1750Hz Tone Burst</li> <li>•2100Hz: PTT + SK1 = Transmits 2100Hz Tone Burst</li> </ul>	Transmits 1000Hz, 1450Hz, 1750Hz tone bursts to activate sleeping repeaters. To send out a tone-burst; you simultaneously will press a key while holding down the PTT.
44	Freq Step	2.5, 5.0,6.25, 10.0, 12.5, 20.0,25.0,50.0K Hz	Selects the amount of frequency change in VFO/ Frequency mode when scanning or pressing the $\wedge/\vee$ keys.
45	Busy Lockout	<ul style="list-style-type: none"> <li>•OFF: the user can transmit all the time.</li> <li>•ON: the radio can transmit only if the channel is free.</li> </ul>	This option prevents the user from transmitting on channels that are already in use.
46	Side Tone	OFF ON	This function is used eliminate squelch tail noise between BaoFeng handhelds that are communicating directly (no repeater). Reception of a 55 Hz or 134.4 Hz tone burst mutes the audio long enough to prevent hearing any squelch tail noise.
47	Alarm Mode	<ul style="list-style-type: none"> <li>•ON SITE: Sounds alarm through your radio speaker only</li> <li>•SEND SOUND: Transmits a cycling tone over-the-air</li> <li>•SEND CODE: Transmits '119' (911 in reverse?) followed by the ANI code over-the-air</li> </ul>	SITE: Sounds alarm through your radio speaker only TONE: Transmits a cycling tone over-the air CODE: Transmits '119' (911 in reverse?) followed by the ANI code over-the-air
48	PF1 Press	<ul style="list-style-type: none"> <li>•None:No Function</li> <li>•Torch On/Off</li> <li>•Power Select</li> <li>•Scan On/Off</li> <li>•VOX On/Off</li> <li>•Alarm on/off</li> <li>•Radio on/off</li> </ul>	You can program these keys for different functions



49	PF1 LongPre	<ul style="list-style-type: none"> <li>•None: No Function</li> <li>•Torch On/Off</li> <li>•Power Select</li> <li>•Scan On/Off</li> <li>•VOX On/Off</li> <li>•Alarm on/off</li> <li>•Radio on/off</li> </ul>	You can program these keys for different functions
50	PF2 Press	<ul style="list-style-type: none"> <li>•None: No Function</li> <li>•Torch On/Off</li> <li>•Power Select</li> <li>•Scan On/Off</li> <li>•VOX On/Off</li> <li>•Alarm on/off</li> <li>•Radio on/off</li> </ul>	You can program these keys for different functions
51	ABR - Display Illumination Time	0 N   5   10   15   20	Time-out for the LCD backlight. (seconds)
52	Brightness	1-5	Setting the brightness of the LCD screen
53	LCD Reflex	<ul style="list-style-type: none"> <li>•Normal: Normal background</li> <li>•Reflex: Grey background</li> </ul>	Setting the LCD transmissive display effect
54	AUTOLK – Automatic Keypad Lock	OFF   5   10   15	Set the automatic keyboard lock delay time. To prevent the keyboard from being accidentally triggered. When turned on, if the keyboard is not used within a predetermined delay time, the keyboard
55	Radio Interr	<ul style="list-style-type: none"> <li>•OFF: When FM radio is used, the radio will not permit a transmission or reception.</li> <li>•ON: When FM radio is used, you can still receive or transmit on the channel.</li> </ul>	Set the radio monitor function to listen to walker calls or not in FM radio mode.
56	Reset – Restore defaults	<ul style="list-style-type: none"> <li>•VFO: Reset frequency only</li> <li>•ALL: Reset frequency and menu functions</li> </ul>	Resets the radio to factory defaults, with some exceptions.
57	STOP WATCH		Activate the stopwatch function. Press the MENU key to start timing.
58	VERSION	Firmware	Access hardware and firmware information for the radio



Visit [baofengradios.com](http://baofengradios.com) for Download and Help

### Disclaimer

The accuracy and completeness of the contents in this manual have been carefully reviewed during compilation. However, we do not assume any responsibility for any errors or omissions. Due to continuous technological advancements and product improvements, we reserve the right to modify the design, specifications, and features of the product without prior notice. No part of this handbook may be copied, modified, translated, or distributed in any form without prior written permission from our department.

## Contact Us:

### Manufactured by:

Shopperclue Webtrade India Pvt. Ltd.  
Unit 461, Spaze IT Park Sohna Road  
Sector 49, Gurgaon Haryana 122018  
Email: [support@baofengradios.com](mailto:support@baofengradios.com)  
Mob. No. : +91-9999323328

### Sales & Marketed By:

G.S. TeleCommunication Limited  
Unit 461, Spaze IT Park Sohna Road  
Sector 49, Gurgaon Haryana 122018  
Email: [support@baofengradios.com](mailto:support@baofengradios.com)  
Mob. No. : +91-9999323328